

9 CONFINED SPACES

Complies with changes to the Construction Regulation (O. Reg. 213/91) implemented in 2006.

Before letting a worker enter a confined space, the employer must develop a written confined space program meeting the requirements of the Construction Regulation (Part II.1, Confined Spaces, sections 221.1 to 221.19). The employer must maintain the program.

CONFINED SPACE PROGRAM

Among the first requirements for employers developing a confined space program is the need to assess which workers will be entering the confined space and therefore which workers will need a copy of the confined space program.

Employers must provide a copy of the program to the constructor of a project. In turn, the constructor must provide a copy of the program to the project's joint health and safety committee or health and safety representative, if any. A copy must also be available to other employers to which the program relates and every worker if there is no project joint health and safety committee or health and safety representative.

If workers from more than one employer will be entering the confined space, the constructor must prepare a **confined space coordination program**. A copy of the confined space coordination document must be provided to each employer who is performing work in the confined space and to the project's joint health and safety committee or the health and safety representative.

The confined space program can apply to one or more confined spaces.

Program elements must include

- a method of recognizing each confined space
- a method for assessing the hazards to which workers may be exposed
- a method for developing plans for controlling the hazards
- a method for training workers
- an entry permit system setting out measures and procedures to be followed when working in a confined space.

Coordination

When workers of more than one employer perform work in the same confined space the constructor must prepare a coordination document to ensure that the various employers perform their duties in a way that protects the health and safety of all workers. A copy of the coordination document must be provided to

- each employer of workers who perform work in the same confined space
- the project's joint health and safety committee or health and safety representative.

RECOGNIZING A CONFINED SPACE

A confined space can be defined as a place

- a) that is **partially or fully enclosed**
- b) that is not both designed and constructed for **continuous human occupancy**, and
- c) where **atmospheric hazards** may occur because of its construction, location, or contents, or because of work that is done in it.

All three criteria have to be met before a space is defined as a confined space. Here is more information on each of the criteria.

Partially or fully enclosed

Because air cannot move freely in and out of a partially or fully enclosed space, there is a potential for a hazardous atmosphere to be generated inside. This is especially true for spaces such as vaults, tanks, pits, trenches, or manholes.

Not designed and constructed for continuous human occupancy

Confined spaces are not designed or constructed for people to work in them on an ongoing basis. They are usually designed and constructed to store material, transport products, or enclose a process. But occasionally, some work must be done inside the space.

Atmospheric hazards

A hazardous atmosphere is one which contains any of the following:

- an accumulation of flammable, combustible, or explosive agents
- less than 19.5% or more than 23% oxygen, or
- an accumulation of atmospheric contaminants that could result in **acute** (short-term) health effects which
 - a) pose an immediate threat to life, or
 - b) interfere with a person's ability to escape unaided from a confined space.

HAZARD ASSESSMENT

Before each time that a worker enters a confined space, a **competent worker** must perform a written hazard assessment. The name of the competent worker must appear on the assessment and the employer must keep a record of the competent worker's qualifications.

The hazard assessment must take into account

- a) the hazards that may exist in the confined space
- b) the hazards that may develop while work is performed inside the confined space
- c) general safety hazards in the confined space.

The competent worker must sign and date the assessment and give it to the employer.

If requested, the employer must give copies of the assessment and competent worker's qualifications to

- the project's joint health and safety committee, or
- the health and safety representative, or
- every worker involved in the confined space entry if the project has no joint health and safety committee or health and safety representative.

COMPETENT WORKER

in relation to specific work, means a worker who

- a) is qualified because of knowledge, training and experience to perform the work
- b) is familiar with the *Occupational Health and Safety Act* and the provisions of the regulations that apply to the work, and
- c) has knowledge of all potential or actual danger to health and safety in the work.

The employer must review the assessment as often as necessary to make sure that the plans remain adequate. For example, if the potential chemical hazard changes due to a change in process or equipment use, then the assessment must be changed.

An assessment is generally required for each confined space. But if there are two or more similar confined spaces containing the same hazards then you need only a single assessment document.

To perform a hazard assessment, you need to anticipate potential hazards. Often, the hazards of working in confined spaces are not recognized until it's too late.

For example:

- A mixing tank was inadvertently started while a worker was inside.
- A worker was killed by carbon monoxide gas from a gasoline-powered pump used to drain a pit.

Because construction projects are not limited to new buildings, confined spaces may be encountered in a variety of places. The following table describes typical confined spaces and the most common hazards found there.

Hazards in confined spaces can be divided into two distinct categories: physical hazards and atmospheric hazards.

If control measures (such as continuous mechanical ventilation) are used to ensure that the concentrations of an atmospheric hazard are **controlled** or maintained at an appropriate level (but not eliminated) then the space would still be considered a confined space. If, however, measures are implemented to **eliminate** the possibility that any atmospheric hazards may occur in a space, then the confined space provisions no longer need to apply. Eliminating the possibility that an atmospheric hazard will occur is different from controlling the hazard. If workers must enter the confined space to eliminate the hazards (by steam-cleaning or vacuuming, for example), then the confined spaces provisions apply.

EVERY CONFINED SPACE MUST BE THOROUGHLY ASSESSED AND EVALUATED BY A COMPETENT WORKER TO DETERMINE WHETHER IT IS POSSIBLE TO ELIMINATE THE ATMOSPHERIC HAZARD COMPLETELY.

Even if a space is not defined as a confined space under the regulations, the employer must take every precaution reasonable in the circumstances to protect workers entering the space.

TYPICAL LOCATIONS OF CONFINED SPACES

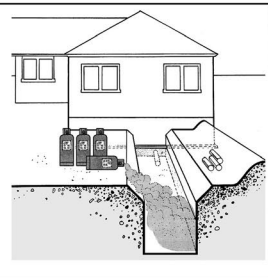
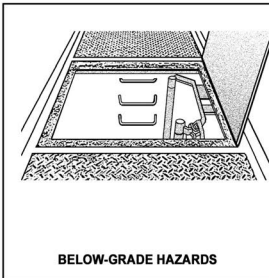
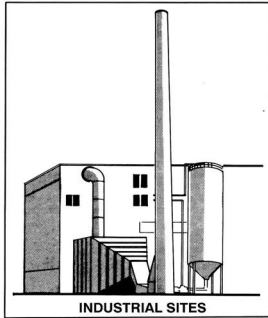
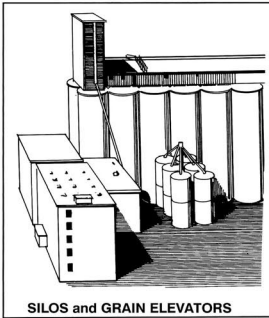
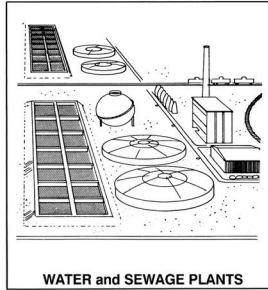
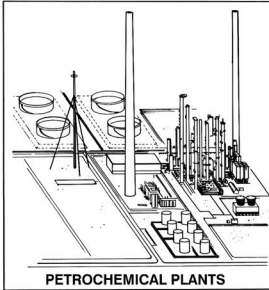

PHYSICAL HAZARDS

Physical hazards often present a greater danger inside an enclosed space than they do outside.

Examples:

► **Noise and vibration**

An enclosed environment can amplify noise. Excessive noise can damage hearing and prevent communication. It can affect workers' ability to hear alarms, warning shouts, or orders to evacuate.

► **Temperature extremes**

Ask plant personnel if workers could encounter dangerous temperatures. For example, heat stress can be a hazard when working around boilers, hot pipe or tanks, or structures heated by the sun. Protective clothing can also add to heat stress.

► **Cramped work spaces**

Cramped work spaces restrict movement and can make using tools and equipment difficult and dangerous.

► **Poor access or exit**

Confined space openings are generally small and not well-located. This can make entry and exit difficult and can interfere with rescue.

► **Rotating or moving equipment**

Before entry, identify any moving or rotating equipment (such as conveyors, mixers, augers, etc.) which could become activated by stored pressure, accidental contact,

Examples of confined spaces	Common hazards
<p>Chemical and petrochemical projects Tanks, vessels, storage tanks, underground tanks, pipes, sumps, pits, any area where a worker cannot readily escape from a toxic or explosive atmosphere; any area where toxic, explosive, or oxygen deficient atmospheres may be encountered.</p>	<p>Toxic and explosive gases, vapours and fumes; physical hazards of cramped entry and exit, narrow passages, and chemical spills.</p>
<p>Sewage handling systems Settling tanks, sewers, manholes, pumping areas, septic tanks, digesters.</p>	<p>Toxic and/or explosive atmospheres such as hydrogen sulphide and methane; oxygen deficiencies.</p>
<p>Water treatment plants Settling tanks, holding tanks, equipment and wells below floor level.</p>	<p>Oxygen deficiency, chlorine gases, ozone; also possibly methane and hydrogen sulphide produced by decaying debris removed from lake and river water.</p>
<p>Heavy industrial projects Sumps, pits, roasters, digesters, mixers, bins, flues, ducts, conveyors, elevators, bag houses.</p>	<p>The hazards will depend on processes and materials involved but may include methane, hydrogen sulphide, oxygen deficiency, flammable agents, electrical hazards, moving parts, and engulfment due to free-flowing materials.</p>
<p>General construction Vaults, caissons.</p>	<p>Toxic materials such as carbon monoxide from temporary heaters in low-lying areas; refrigerants; high-voltage transmission equipment; physical hazards involving poor lighting and cramped working conditions.</p>

or gravity action. Check with plant personnel on lockout and tagging procedures, and review drawings, plans, and specifications.

► Electrical hazards

Any exposed conductors or energized equipment should be identified before entry. The presence of water in confined spaces may pose an additional electrocution hazard where electrical circuits, equipment, and tools are used.

► Engulfment due to uncontrolled movement of liquids and solids

Liquids, sludge, fine solids, and other material may not be completely removed from confined spaces and may present an engulfment or drowning hazard. Use inspection ports and dipsticks, and check with plant personnel to evaluate such hazards.

► Slick or wet surfaces

You can be severely injured from a slip or fall on icy, oily, wet, or moist surfaces.

► Lighting

Confined spaces generally have poor lighting. You often need temporary lighting. In potentially explosive atmospheres, use lighting designed for such situations.

ATMOSPHERIC HAZARDS

Confined spaces can present three kinds of atmospheric hazards:

- flammable, combustible, or explosive atmosphere
- oxygen-enriched or oxygen-deficient atmosphere
- atmospheric contaminants.

The hazardous atmosphere may be due to existing conditions (e.g., residue in a tank,) or it may be created by the work being done inside the confined space (e.g., welding or using solvents). In some cases, removing sludge or scale can release trapped pockets of gas or vapour and create a hazardous atmosphere. Moreover, dangerous atmospheres often exist together. For instance, flammable, combustible or explosive atmospheres may also be toxic or cause an oxygen deficiency.

FLAMMABLE, COMBUSTIBLE, OR EXPLOSIVE ATMOSPHERES

Flammable atmospheres are generally caused by

- evaporation of flammable liquids (e.g., gasoline)
- by-products of chemical reactions (e.g., decomposition of organic matter to form methane).

Explosive atmospheres are those in which a flammable gas or vapour is present in quantities between the Lower Explosive Limit (LEL) and the Upper Explosive Limit (UEL). These limits define the “Explosive Range” which varies from one substance to another. Refer to the section

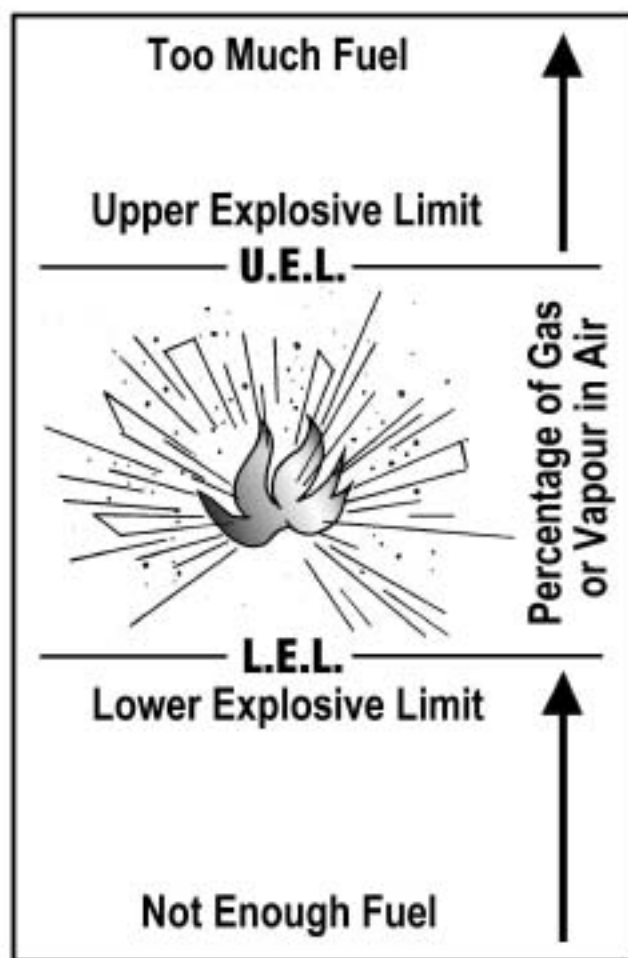

“Fire and Explosion Hazard” of a material’s MSDS for fire- and explosion-related information.

The LEL is the lowest, and the UEL the highest concentration of gas or vapour that will support combustion. For example, gasoline has an LEL of 1.4% and a UEL of 7.6%. Below 1.4% there is not enough fuel to burn, while above 7.6% there is too much fuel and not enough oxygen to burn. (See figure above.)

The most common explosive gas likely to be encountered in sewers and other underground structures is methane-or “natural gas”-produced by decaying garbage and sewage.

Other explosive gases and vapours may be present in confined spaces depending on previous contents or accidental spills and leaks (e.g., leaking fuel-storage tanks near service stations).

Explosive ranges for common gases and vapours are listed in Table 1. These values must be considered when selecting and operating gas-testing equipment.

Combustible atmospheres can arise in grain elevators, feed mills, and some industrial settings such as bag houses, because of the large quantities of dust generated. The most common combustible dust is grain or flour dust-there have been several explosions in grain elevators. You need to address this issue whenever you’re working in these settings.

Table 1
Explosive Range for common gases and vapours

Gas/vapour	Lower Explosive Limit (%)	Upper Explosive Limit (%)
Acetone	2.6	12.8
Ammonia	16.0	25.0
Benzene	1.3	7.1
Ethyl Alcohol	3.3	19.0
Gasoline	1.4	7.6
Hexane	1.1	7.5
Hydrogen Sulphide	4.0	44.0
Methane	5.0	15.0
Methyl Alcohol	7.3	36.0
Propane	2.4	9.5
Toluene	1.2	7.1
Xylene	1.1	7.0

OXYGEN-ENRICHED AND OXYGEN-DEFICIENT ATMOSPHERES

Normal outside air contains about 21% oxygen. If the concentration of oxygen exceeds 23% it is considered “enriched”. The primary concern with oxygen-enriched atmospheres is the increased flammability of materials. Things that would only smoulder in normal air will burn vigorously in oxygen-enriched atmospheres.

Oxygen-enriched atmospheres are fairly rare in construction. They are usually associated with pure oxygen escaping from leaking or ruptured oxyacetylene hoses or, on projects in industrial plants, from an oxygen line in an industrial or manufacturing process.

Oxygen-deficient atmospheres, on the other hand, are fairly common. They may result from work being done (such as welding), bacterial action (which consumes oxygen), or from chemical reactions (such as rusting). Oxygen may also be displaced by another gas or vapour (e.g., carbon dioxide or nitrogen used to purge tanks, pipe, and vessels). Table 2 lists the effects of oxygen deficiency.

Table 2
Effects of oxygen deficiency

Oxygen concentration	Effect
19.5%	Minimum for safe entry
Less than 18%	Loss of judgment and coordination
Less than 15%	Loss of consciousness
Less than 12%	Sudden collapse and loss of consciousness

Never use pure oxygen to ventilate a confined space. Use clean air.

ATMOSPHERIC CONTAMINANTS

Because confined spaces are poorly ventilated, atmospheric contaminants can build up to hazardous levels very quickly. For construction in an industrial setting, the type of airborne hazard that may be encountered depends on

- products stored in the confined space
- the type of work tasks performed in the confined space
- work or processes being performed near the confined space.

The most common atmospheric contaminants in construction include hydrogen sulphide, carbon monoxide, sulphur dioxide, chlorine, and ammonia.

Hydrogen Sulphide (H₂S) is a gas generated by the decomposition of garbage and sewage. H₂S can be found in sewers, sewage treatment plants, refineries, and pulp mills. It is also found in many oil refineries since most crude oil in Canada has some H₂S dissolved in it. H₂S is very toxic. A single breath at a concentration of about 500-700 ppm (parts per million) can be instantly fatal. At very low concentrations, H₂S has the characteristic odour of rotten eggs. However, at about 100 ppm it can deaden your sense of smell and create the false impression that no hazard exists.

Carbon Monoxide (CO) is a very common toxic gas. It has no odour or taste and is clear and colourless. Carbon monoxide poisoning can be very subtle and may cause drowsiness and collapse followed by death. The major sources of CO in construction include the internal combustion engines powering saws, scissor lifts, power trowellers, generators, and forklift trucks. Even these relatively small engines produce high levels of CO.

Heating in confined areas, particularly with propane, presents special hazards and requires special safeguards. Propane is heavier than air and can collect in low-lying areas such as trenches, basements, and shaft bottoms. Propane can also be absorbed into clothing. Workers must therefore use extreme caution in the event of leakage or flame-out.

Direct-fired heaters release combustion emissions directly into the air where people work. Although carbon monoxide (CO) is the main concern, carbon dioxide (CO₂) and nitrogen oxides may also be a problem.

Adequate ventilation is absolutely essential when you cannot avoid using combustion engines in confined spaces.

Traditionally, explosive blasting has been used for demolition or breaking up rock. Blasting in a confined space can produce high levels of carbon monoxide. You must use mechanical ventilation and perform air tests before workers re-enter the blast area to ensure that the carbon monoxide levels are within acceptable levels.

CO in atmosphere (parts per million)	Signs and symptoms
10	No symptoms
25	TWAEV (Time-Weighted Average Exposure Value): The maximum average amount a worker is allowed to be continuously exposed to for a work day or work week.
70	Blood vessels widen, shortness of breath, tightness across the forehead
100	STEV (Short-Term Exposure Value): The maximum amount a worker is allowed to be exposed to for a 15-minute period.
120	Shortness of breath, headache with throbbing in temples
220	Headache, irritability, tiredness, impaired judgment, impaired vision, dizziness
350–520	Headache, confusion, fainting, collapse
800–1220	Unconsciousness, spasms, respiratory failure, death if exposure continues
More than 2000	Rapidly fatal



Blocked opening

Do not restrict ventilation by blocking openings

Sulphur Dioxide (SO₂) is a very irritating and corrosive gas with a strong sulphur-like odour which can be found in pulp-and-paper mills and oil refineries.

Chlorine (Cl₂) is another irritating and highly corrosive gas with a bleach-like odour used as a disinfectant in water and sewage treatment plants and a wide variety of other industrial settings.

Ammonia (NH₃) is a fairly common chemical used as a refrigerant and in making fertilizer, synthetic fibres, plastics, and dyes.

Hundreds of other toxic materials may be encountered in factories, chemical plants, and similar industrial settings. The best way to obtain information regarding the presence or absence of toxic materials is to discuss the proposed work with the client and ask for the information.

FLAMMABLE PRODUCTS

When using flammable materials in a confined space, take these precautions:

- ✓ Provide adequate ventilation.
- ✓ Control sparks (use non-sparking tools) and control other potential ignition sources
- ✓ Extinguish all pilot lights.
- ✓ Use specially protected lighting.
- ✓ Have fire extinguishers handy.

Contact cement is an example of a product with fire or explosion potential when used in a small area with poor ventilation. Workers have been killed from explosion and fire when they finished work and switched off the light in a room where solvent vapours from contact cement or adhesives had accumulated.

ACCUMULATION OF CONTAMINANTS BELOW GRADE

Trenches, manholes, and low-lying areas may become hazardous from leaking gases heavier than air—such as propane—or from gasses such as carbon monoxide seeping through the soil and into the confined space.

Case study

A construction crew finished installing a 12-foot-deep manhole without incident. After the crew left the area, 265 pounds of nitroglycerin-based explosive in 20 boreholes, each 18 feet deep, were detonated 40-60 feet from the manhole. A worker who entered the manhole 45 minutes after the explosion collapsed within minutes, and two coworkers descended into the manhole to rescue him. One rescuer retrieved the unconscious worker before collapsing on the surface, and the other rescuer died in the manhole.

An investigation determined that carbon monoxide released from the explosion had migrated through the soil into the manhole. Carbon monoxide concentrations at the bottom of the manhole two days after the incident were 1,905 ppm (parts per million). This concentration was well above 1,200 ppm, the concentration classified as Immediately Dangerous to Life or Health (IDLH). Tests following ventilation of the manhole showed that high levels of carbon monoxide reappeared as a result of continued migration from the surrounding soil. Subsequent monitoring of the manhole showed a decline in carbon monoxide levels over the next 8 days.



Workers should be aware of this hazard. At the first sign of discomfort or disorientation they should leave the area until it has been ventilated.

Workers feeling light-headed or experiencing headaches may be inhaling these pollutants. Drowsiness or disorientation can lead to falls. Again, leave the area until it has been ventilated.

Underground mines, tunnels, and shafts

These spaces are intended for people to carry out work in them-this work is covered by specific regulation. They may present physical or atmospheric hazards. Many utilities are routed through tunnels or underground shafts where hazardous atmospheres may collect from containers or operations above, or be created by utility leaks (such as gas and oil).

Work in shafts must be carefully planned. Because the work may be of short duration and require only a temporary platform, these jobs are often not given proper attention.

In addition to the areas already described, beware of apparently harmless areas such as basements, halls, and small rooms that can become dangerous when a lack of ventilation and hazardous materials or operations combine to create atmospheric hazards.



ACCUMULATION OF CONTAMINANTS IN AREAS NOT CLASSIFIED AS CONFINED SPACES

A variety of spaces can become hazardous because of the products being used or the work being done in them. These areas can be deadly even if they are not classified as confined spaces and even if the confined space provisions of the Construction Regulation do not apply.

Skylights, domes, and ceilings

Work is sometimes required within newly installed skylights where lighter-than-air gases and fumes may accumulate.



If a worker can be injured by inhaling a hazardous gas, vapour, dust, or fume or there is an explosion hazard then you must provide adequate ventilation by natural or mechanical means. If this is not possible then you must provide respiratory protection equipment suitable for the hazard.

PLAN FOR CONTROLLING HAZARDS

Once the hazards have been identified in the assessment, a **competent person** must develop a **plan** to eliminate or control the hazards.

COMPETENT PERSON

means a person who

- a) is qualified because of knowledge, training and experience to **organize the work** and its performance
- b) is familiar with the *Occupational Health and Safety Act* and the regulations that apply to the work, and
- c) has knowledge of any potential or actual danger to health and safety in the workplace.

The primary objective of the **plan** is to eliminate the hazard before entry. If this is not possible, then controls, measures, and procedures must be put in place to ensure that workers are not in danger.

If confined spaces are of similar construction and present the same hazards, a single plan can be used. Still, the individual confined spaces must be identified in both the hazard assessment and the plan.

The Plan is the program element with the most regulatory requirements attached to it. The regulation outlines 11 mandatory requirements that must be contained in the plan:

- 1) Duties of workers
- 2) Coordination document (prepared by the constructor) if workers of more than one contractor enter the same confined space
- 3) On-site rescue procedures
- 4) Rescue equipment (inspected by a competent worker) and methods of communication
- 5) Protective clothing and protective equipment
- 6) Isolation of energy and control of material movement
- 7) Attendants
- 8) Adequate means of access and egress (entry and exit)
- 9) Atmospheric testing (conducted by a competent worker)
- 10) Adequate procedures for working in the presence of explosive or flammable substances
- 11) Ventilation and purging.

We address each of these 11 mandatory requirements below.

1) DUTIES OF WORKERS

- a) Do not enter or re-enter (if the confined space has been left unoccupied and unattended) the confined space unless testing has been performed.
- b) Know the hazards that may be faced upon entry. Know the route of exposure (e.g., inhalation or skin absorption), signs and symptoms, and long-term effects of exposure.
- c) Know how to use the equipment (including personal protective equipment and tools) properly.
- d) Maintain communication with the attendant so that the attendant can monitor your safety and be able to alert workers to evacuate the confined space.
- e) Alert the attendant whenever:
 - you recognize any warning sign or symptom of exposure
 - you see a dangerous condition
 - an alarm is activated.
- f) Get out of the permit space immediately whenever
 - a warning system indicating a ventilation failure is activated
 - the attendant gives an evacuation order
 - a worker recognizes any signs or symptoms of exposure
 - a person inside detects a dangerous condition
 - an evacuation alarm is activated.

2) COORDINATION

When workers of more than one employer perform work in the same confined space, the constructor must coordinate entry operations. The constructor must prepare a coordination document to ensure that the various employers perform their duties in a way that protects the health and safety of all workers entering the confined space.

A copy of the coordination document must be provided to each employer of workers who perform work in the confined space and the project's joint health and safety committee or health and safety representative.

Each employer is responsible for the health and safety of their own workers and for ensuring compliance with the regulation.

3) RESCUE PROCEDURES

The confined space plan must include written procedures for safe onsite rescue that can be implemented immediately in case of an emergency. An adequate number of people must be available to carry out the rescue procedures immediately. They must be **trained** in

- a) the onsite rescue procedures
- b) first aid and cardio-pulmonary resuscitation (CPR)
- c) how to use the rescue equipment necessary to carry out the rescue.

Dialing 911 is not a sufficient rescue response.

4) RESCUE EQUIPMENT

The rescue equipment must be readily available, appropriate for the confined space, and inspected by a competent worker. The competent worker must keep a written record of the inspection. Examples of rescue equipment include harnesses and lifelines, hoist/retrieval systems, respirators, and other personal protective equipment.

NOTE: You must consider the size of the confined space's opening when choosing rescue equipment. There is no point planning for a rescuer to wear a SCBA (self-contained breathing apparatus) unit if it doesn't fit through the opening.

All too often, inadequate or incorrect emergency rescue response results in multiple fatalities. Here are two examples:

- A worker collapsed shortly after entering a degasser tank. His coworker went in after him and collapsed as well.
- A contractor went to test acid-tainted water and was discovered by a worker floating in a well of the above-ground pump house. The worker went to his rescue after calling 911 but was himself overcome. Two paramedics responding to the call were also struck down. All four victims died.

Even with the best planned and executed entry there is a chance of a sudden change in conditions. The change could be due to factors recognized earlier but for which no "absolute" protection exists, such as the failure of a respirator, the introduction of a new hazard, or collapse from heart attack or illness. In such cases you need a rescue plan that has been practiced and works.

Remember, rushing into a confined space to help your buddy who is laying on the ground will likely result in your own death. Rescuers are no good to the victim if they also become victims. Many cases of multiple fatalities involve would-be rescuers overcome because of inadequate preparation.



5) PROTECTIVE CLOTHING AND PERSONAL PROTECTIVE EQUIPMENT

Protective clothing and equipment suitable for one material may not be suitable for others. For example, polyvinyl chloride (PVC) plastic is resistant to most acids, but it can be softened or penetrated by many common solvents such as benzene, toluene, and xylene.

For this reason, a knowledgeable person should assess the protective clothing and equipment needed (e.g., gloves, boots, chemical suits, fire resistant coveralls—as well as hearing, respiratory, eye, and face protection). Don't forget that if workers need personal protective equipment, they must be trained in its use.

Respiratory protective equipment should be used where ventilation is impractical or inadequate. Certain basic rules apply to the equipment.

First of all, you need to select the proper type of respirator. Oxygen-deficient atmospheres require supplied-air respirators—either airline types with emergency reserves or SCBA (self-contained breathing apparatus) as in the figures on the next page.

SCBA note: Because the amount of air supply in standard SCBA cylinders is rated for a specific time period, it is very important to plan your tasks, especially rescue operations, accordingly. Heavy work and stress will increase breathing rates and workers will use up the air in less than the rated time. An alarm sounds when the air supply is low.

In toxic atmospheres, you must use supplied-air respirators if the concentration of the gas or vapour exceeds the level considered to be Immediately Dangerous to Life or Health (IDLH), or if the concentration is unknown.

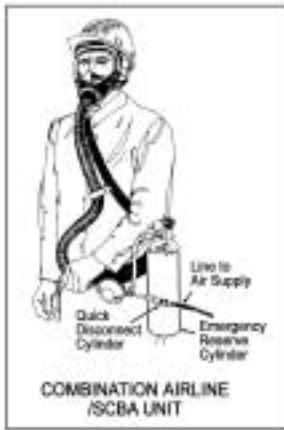

When the level of toxic gas or vapour is above the exposure limit but below the IDLH level, air-purifying respirators approved by the National Institute of Occupational Safety and Health (NIOSH) may be used provided the exposure conditions do not exceed the unit's limitations. Someone who is competent in respirator selection must determine the appropriate type of respirator.

Workers required to wear respirators must be instructed how to properly fit and maintain them. For more information on respiratory protection, refer to the chapter on personal protective equipment in this manual, or the Canadian Standards Association's standard Z94.4-02, *Selection, Use, and Care of Respirators*.

Do not use single-strap dust masks and surgical masks—they are not approved by the National Institute for Occupational Safety and Health (NIOSH). NIOSH is a U.S.-based organization that approves respirators. Workers must be supplied with NIOSH-approved respirators only. All NIOSH-approved respirators have an approval number (always starting with the letters TC) on them.

Make sure your respirator has all the proper parts. Since each manufacturer uses different designs, parts are not interchangeable between brands. Make sure you use the correct parts (cartridges, air cylinders, etc.) for your brand of respirator. Never use cartridges or air cylinders from another manufacturer. They will not fit correctly and will endanger the life of the worker or rescuer.

6) ISOLATION OF ENERGY AND CONTROL OF MATERIAL MOVEMENT

Equipment that moves in any way (even rotation) must be isolated by

- disconnecting the equipment from its power source and de-energizing the equipment, or
- lockout and tagging. Only workers trained in lockout and tagging should perform such operations. Lockout and tagging should be done even if you use the first option (disconnect and de-energize) to isolate the energy.

For pneumatic or hydraulic equipment, isolate the power source and depressurize the supply lines. Depressurize any components that may still be pressurized after the supply lines have been bled—hydraulic cylinders for example. You must disconnect and drain pipes carrying solids or liquids to or from a confined space, or insert blank flanges.

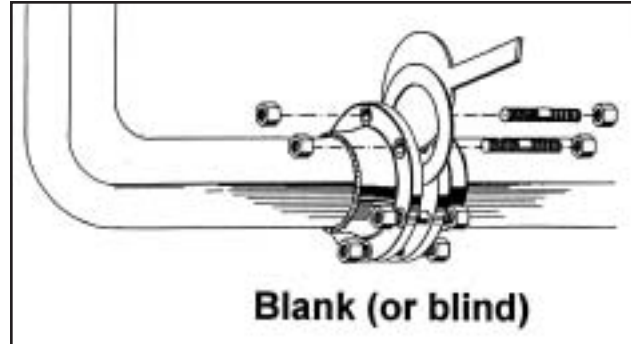

If the pipe cannot be blanked off or disconnected, the valve may be closed, chained, locked and tagged, provided that this type of control—and its importance—have been explained to all workers in the area. **Simply closing valves is not generally acceptable.**



You may need blocking to prevent movement caused by gravity for some equipment (e.g., conveyors).

Electrical equipment in the space should be disconnected, tagged and locked out, and grounded when it's practical to do so.

In the case of live electrical work in a confined space, you need to pay special attention to standard procedures. A minor mistake in a manhole can lead to disaster.

Cramped working conditions can make accidental contact with an energized conductor more likely, so you may need non-conductive equipment.

You may need gloves, mats, and other insulating equipment depending upon the type of work. Capacitors or other components which can store a charge should be discharged and/or grounded.

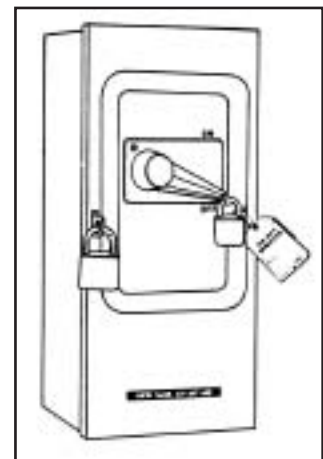

7) ATTENDANT

An attendant must be present whenever a worker enters a confined space. The attendant is not allowed to enter the confined space, unless he or she is replaced by another attendant in accordance with the plan.

The attendant must

- ✓ remain alert outside and near to the entrance
- ✓ be in constant communication (visual or speech) with all workers in the confined space
- ✓ monitor the safety of workers inside the confined space
- ✓ provide assistance as necessary
- ✓ be provided with a device for summoning help in case of emergency, and
- ✓ initiate an adequate rescue procedure in case of an emergency.

The attendant is not allowed to enter the confined space to perform a rescue even after help has arrived unless he or she is replaced by another attendant in accordance with the plan.

8) ENTRY AND EXIT (ACCESS AND EGRESS)

The means of entry and exit can be evaluated before entry by checking drawings, by prior knowledge, or simply by inspection from outside the space.

Confined space openings are generally small and not well located. These small openings must be considered in the rescue plan since they restrict the movement of workers and equipment in and out of confined spaces.

Entry and exit for top-side openings may require ladders. Ladders must be well secured. Performing an emergency rescue on workers trapped in such areas requires careful planning and practice.



9) ATMOSPHERIC TESTING

If the hazard assessment determines that there is an atmospheric hazard in the confined space, you must perform atmospheric testing.

- 1) The employer must appoint a competent worker to perform adequate tests safely before and during the time a worker is in a confined space to ensure that acceptable atmospheric levels are maintained. The competent worker who will perform the tests must receive training in the operation, calibration, and maintenance of the instruments. Most manufacturers can provide necessary training.
- 2) If the confined space has been left unoccupied and unattended, you must perform the testing again.
- 3) The competent worker performing the tests must use properly calibrated and maintained instruments (Figure 3) appropriate for the hazards in the confined space.
- 4) Results of every sample of a test must be recorded on the entry permit. If continuous monitoring is performed, test results must be recorded at adequate intervals.

Gas detection instruments

Gas detection instruments can take many forms- "personal" or "area," single-gas or multiple-gas detectors, detectors with dedicated sensors or those with interchangeable sensors.

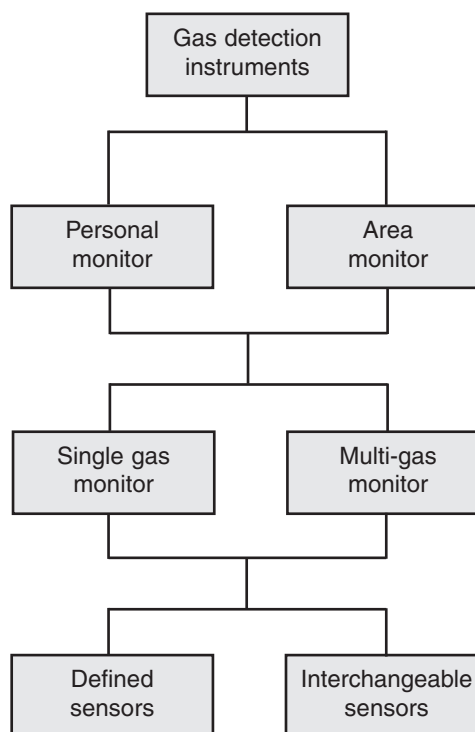

If a monitor is worn by the worker it is referred to as "personal monitoring."

Personal monitoring gives information about the concentration of hazardous substances

surrounding the worker. It is particularly useful when the worker is moving from place to place within the confined space.



Area sampling is done before entry or re-entry. As much of the confined space area as possible should be tested, including the bottom, mid level, top, and corners.

Single-gas detectors measure only one gas while multi-gas monitors are available with several toxic sensor options and have the flexibility of measuring many gases simultaneously. Most multi-gas monitors include an oxygen sensor, a flammable/combustible gas sensor, and one or two sensors for detecting specific toxic gases. Newer single and multi-gas instruments offer the flexibility of interchangeable sensors. You can change the sensors to suit the application in hand. For example, a single-gas detector used to check hydrogen sulphide levels can be used to monitor carbon monoxide concentrations after you change the sensor.



Key steps to follow when you suspect a dangerous atmosphere

Select the appropriate type of calibrated instruments for the hazards identified in the assessment.

You must understand the characteristics of the work area in order to choose the right instruments. Different types of confined spaces present different kinds of toxic gas hazards. There are hundreds of different toxic gases or vapours. You need a familiarity with the characteristics of the confined space in order to narrow down the possibilities and choose equipment.

You must use a calibrated monitor that is capable of measuring the hazardous atmosphere found in the confined space. For example, if a propane heater is being used inside a confined space, then you need calibrated monitors capable of measuring oxygen levels, carbon monoxide, and combustible gases.

WARNING: Combustible gas detectors should not be used to assess toxic atmospheres. Most combustible gas detectors do not respond to low concentrations of gases. For example, H₂S is flammable from 4.3% to 44%. But it is Immediately Dangerous to Life or Health (IDLH) at 100 parts per million (0.01%) and would not be detected at this concentration by most combustible gas detectors. Most other toxic gases that are also flammable are dangerous in concentrations well below the LEL.

You must calibrate, maintain, and use the equipment in accordance with the manufacturer's recommendations.

If the meter is not properly calibrated, you cannot rely upon its results. Deaths can occur if the instrument underestimates the atmospheric conditions.

Most confined-space instrument manufacturers now offer "docking" stations that can automatically calibrate instruments and print a record of calibration. The stations also recharge and store the instruments.



Perform the tests safely.

Entry into a confined space must be prohibited before the appropriate tests are performed. Atmospheres should be evaluated remotely (from outside the confined space) before each entry. If possible, an extendable probe should be inserted through an inspection port or other opening before removing large doors or covers.

Make sure that as much of the space as possible is tested, including the bottom, mid-level, top, and corners, so that you don't miss layers or pockets of bad air. (See figure below). There are some gases that are lighter or heavier than air. Lighter gases, such as methane, will accumulate at the top, while gases heavier than air will sink to floor level. Gases that are the same weight as air, such as carbon monoxide, will be found throughout a confined space.

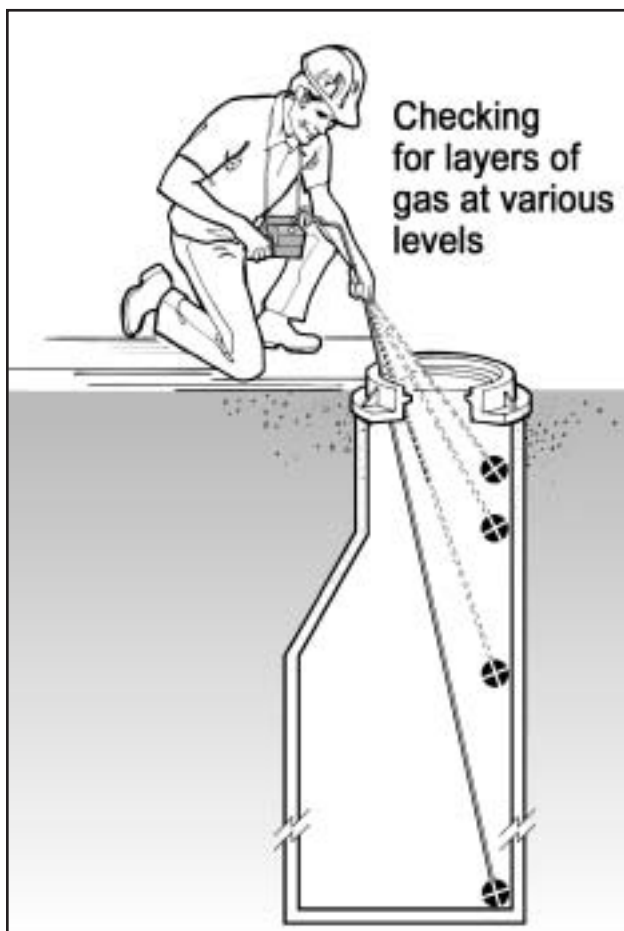

Check for oxygen content, combustible or explosive gases and vapours, and toxic gases and vapours in that order if you use more than one meter.

First, check for oxygen content. Checking oxygen first is important because you may need adequate oxygen to get a valid result from other tests.

If the oxygen level is adequate, test for explosive atmospheres. Several different calibration gases are available. Methane is used most frequently since it is a common gas found in many places. But you can get devices calibrated for propane, hexane, heptane, or

almost any other combustible gas. These devices give a result expressed as a percentage of the lower explosive limit (LEL) for the calibration gas used.

The next thing to check for is the presence of toxic gases and vapour using a calibrated instrument.

If you're using a multi-gas monitor capable of measuring oxygen, combustibles, and toxic gases simultaneously then the order of testing is not as critical.

All three types of dangerous atmospheres must be evaluated before entry. Users of gas detectors must be competent workers. They must also receive training in the operation, calibration, and maintenance of the devices. Most manufacturers can provide necessary training.

Always test for the three dangerous atmospheres:

- too much or too little oxygen
- combustible or explosive gases or vapours
- toxic gases or vapours.

You may need to monitor the atmosphere continuously.

Continuous monitoring in a confined space is required while hot work is being performed in a potentially flammable or explosive atmosphere or where the flammable or explosive atmosphere has been rendered inert by adding an inert gas. It should also be considered when conditions in the confined space change rapidly.

If continuous monitoring is performed then test results must be recorded at regular intervals.

Most confined space instruments have data-logging capabilities. Data-logging is useful for compliance and record-keeping purposes. If an accident or unusual event happens, data-logging may be useful for demonstrating due diligence.

Interpret the results.

There may be other gases present in the confined space that interfere with the reading for the gas you are trying to measure. Such gases are referred to as "interfering gases." They can lead to misinterpretation of the monitoring results.

Know the limitations of your specific equipment. Consult the manufacturer's instructions for proper use.

Temperature, humidity, and interfering gases can all affect the performance of gas monitors.

If the atmosphere meets acceptable exposure limits (see next page) the confined space may be entered. If the atmosphere does not meet acceptable limits, you need to implement controls before anyone can enter.

Acceptable atmospheric levels

Explosive or flammable gas or vapour	<p>< 25% of its lower explosive limit: inspection work can be performed.</p> <p>< 10% of its lower explosive limit: cold work can be performed. (Cold work is work which does not involve</p> <ul style="list-style-type: none"> – welding and cutting – the use of tools or equipment which can produce a spark – other sources of ignition.) <p>< 5% of its lower explosive limit: hot work can be performed.</p>
Oxygen content	At least 19.5% but not more than 23% by volume.
Exposure to atmospheric contaminants	<p>Exposures to atmospheric contaminants must not exceed what is reasonable in the circumstances (section 221.2 (c) of the Construction Regulation).</p> <p>The exposure limits in the regulation on Control of Exposure to Biological or Chemical Agents (Ontario Regulation 833) and the Designated Substance Regulations* are generally considered reasonable for protecting workers.</p>
<p>* This is the case despite the fact that construction projects are, strictly speaking, exempt from Regulation 833 and most of the Designated Substance Regulations. (The Designated Substance Regulation which does apply to construction is O. Reg. 278/05: Designated Substance-Asbestos on Construction Projects and in Buildings and Repair Operations.)</p>	

If measurements are within acceptable exposure limits but are approaching hazardous levels, the competent worker's decision to proceed should be based on an assessment of the source of the problem, the likelihood of change, and the conditions at the scene. In doubtful cases, it is best to implement the appropriate controls discussed in the following section.

Recording the results.

The test results must be recorded on the work entry permit. The records must be kept by the constructor or employer for at least one year after the project is finished.

- ★ Never trust your senses to determine whether the atmosphere in a confined space is safe.
- ★ You cannot see or smell many toxic gases and vapours.
- ★ You cannot determine by your senses the level of oxygen present.
- ★ Know which gases or vapours may be present in the confined space and test for them.

10) COMBUSTIBLE, EXPLOSIVE, OR FLAMMABLE ATMOSPHERES

No worker is allowed to enter a confined space if airborne **combustible** dust or mist is present in a concentration sufficient for explosion. If an **explosive** or **flammable** atmosphere is detected, you can perform only certain types of work. The conditions for each type of work are specified below the following definitions.

Hot work means activities that could produce a source of ignition such as a spark or open flame. Examples of hot work include welding, cutting, grinding, and using non-explosion-proof electrical equipment.

Cold work means activities that cannot produce a source of ignition.

- a) Between 0% and 5% of the LEL, you can perform hot work. The following conditions must also be met:
 - The oxygen content must be maintained below 23%
 - The atmosphere must be continuously monitored.
 - The entry permit must include adequate provisions for hot work, and it must specify the appropriate measures to be taken.
 - An alarm and exit procedure must be in place to provide adequate warning and allow safe escape if the atmospheric concentration exceeds 5% of the LEL or if the oxygen content exceeds 23%.
- b) Between 0% and 10% of the LEL, you can perform cold work.
- c) Between 0% and 25% of the LEL, you can perform inspection work.

Alternatively, work may be carried out in the confined space if the combustible, explosive or flammable atmosphere is rendered inert by an inert gas (such as nitrogen, argon, helium, or carbon dioxide).

Inerting is the process of replacing the potentially combustible atmosphere in a confined space with a noncombustible gas such as nitrogen, argon, helium, or carbon dioxide.

The atmosphere must be monitored continuously to ensure it remains inert. The worker in the confined space must use adequate respiratory equipment as well as adequate equipment to help people outside the confined space locate and rescue the worker if a problem occurs.

The inert gas will replace all of the **oxygen** as well as the combustible gases in the confined space. Workers entering the confined space should use NIOSH-approved **air-supplied** respirators. After work is completed, the confined space must be properly ventilated, and a competent worker must test the confined space to see if it is safe.

11. VENTILATION/PURGING

This is the most effective method of control. The space can be purged of dangerous atmospheres by blowing enough fresh air in, and/or by removing (or suction-venting) the bad air and allowing clean air in. Studies have shown that the best results are obtained by blowing fresh air into a space close to the bottom. Check the efficiency of ventilation by re-testing the atmosphere with the gas detection equipment before entry.

When ventilation is used to improve the air in a confined space, ensure that the toxic or flammable gases or vapours removed from the space do not pose a risk to other workers. "Exhaust air" should not be discharged into another work area.

If you use mechanical ventilation to maintain acceptable atmospheric levels by providing a continuous supply of fresh air, you must have a warning system (i.e., an alarm) and exit procedure in case there is a ventilation failure. The alarm should be activated by a pressure switch *at the fan* rather than by electrical failure. This ensures that the alarm is activated if the fan belt fails.

In cases where the concentration of explosive gas or vapour is higher than the UEL, ventilation will bring the concentration down into the "Explosive Range." This is one reason why you should use only "explosion-proof" fans. These may be specially designed fans powered by electricity or compressed air. Some pneumatic air movers may also be suitable.

For manholes, you can use portable fans. These usually provide around 750-1,000 cubic feet of air per minute.

A typical manhole 10 feet deep and 5 feet wide

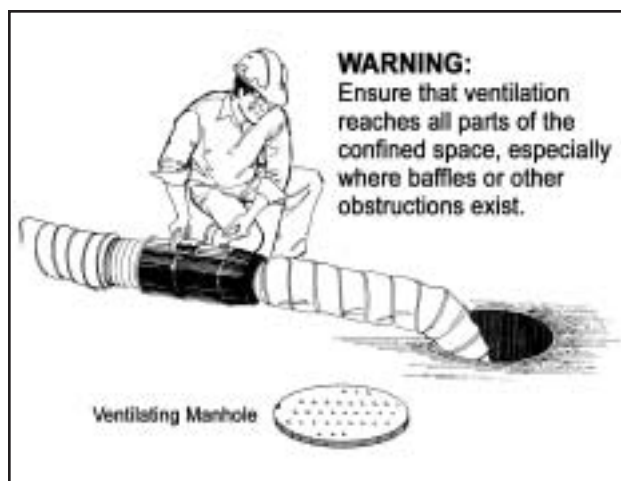

contains 196 cubic feet. Blowing in 750 cubic feet per minute should provide an air change every 15 seconds and easily dilute or displace most dangerous atmospheres.

Fans capable of moving 5,000 cubic feet per minute are available for use in larger tanks and vessels.

This type of ventilation may not be adequate in situations where additional toxic or explosive gases or vapours may be generated (e.g., during cleaning and resurfacing tanks or by disturbing sludge and scale).

In the case of welding or other work which generates a localized source of toxic gas, fume, or vapour, an exhaust ventilator can be used to draw out and discharge the hazard in an open area. (See figure below.)

Options must be evaluated by someone who understands the risks of the work being done.

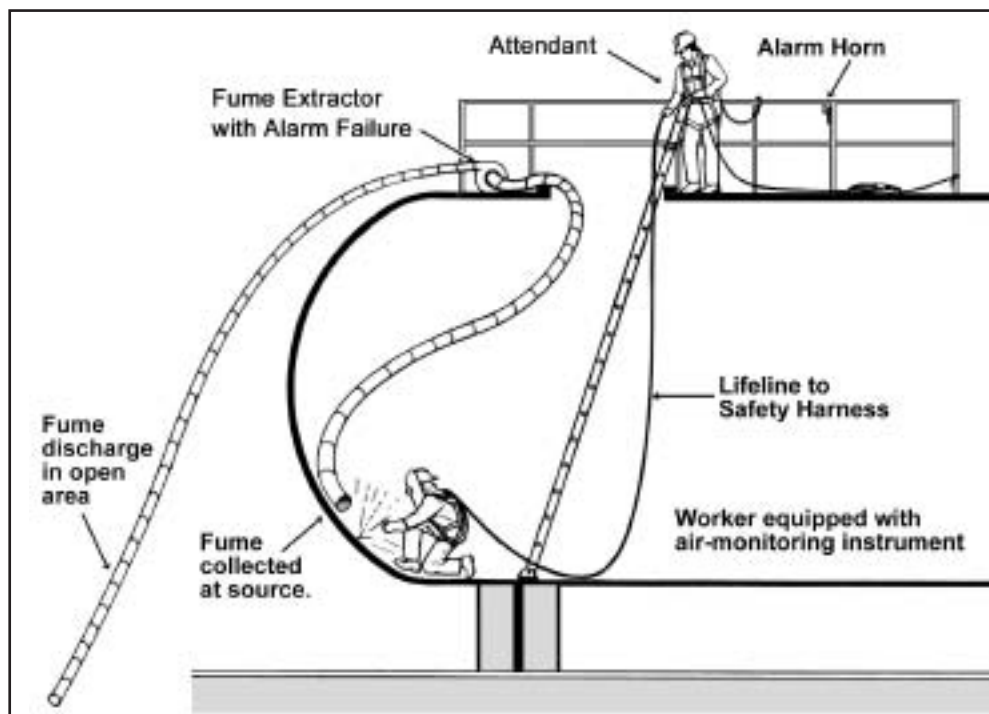

WORKER TRAINING

Workers must be trained before they enter a confined space. The training must include

- ✓ recognizing the hazards (including potential hazards) in the confined space
- ✓ safe work practices, including the use of all equipment such as ventilation equipment, air monitors, and personal protective equipment.

It is strongly recommended that

- the employer use an evaluation procedure (a test) to ensure that workers have acquired the knowledge necessary to safely perform their duties
- inexperienced workers team up with experienced workers.

You must review the content of the training at least annually, and whenever there is a change in circumstances such as a change in an industrial process. If the review indicates that the training is not adequate, you must provide additional training.

You must keep a record of the names of trainers, trainees, as well as the date of training. If the project's joint health and safety committee or health and safety representative wants a copy of the record, you must provide one.

ENTRY PERMITS

Permits are valuable tools for planning, evaluating, and controlling confined space entries.



A permit involves a formal system of procedures and is issued by the employer before any worker enters the confined space. A competent person must verify that the permit issued complies with the plan before every shift. The duration of an entry permit must not exceed the time required to complete the task. Entry permits should be understood by everyone involved in the job and must be readily available to every person entering the confined space.

At the very least, the entry permit must include

- the location and description of the confined space
- a description of the work
- a description of the hazards and the corresponding controls
- the time period for which the entry permit applies
- the name of the attendant
- a record of each worker who enters and leaves
- a list of the equipment required for entry and rescue, and verification that the equipment is in good working order
- the results of the atmospheric testing
- additional procedures and control measures if hot work is to be done.

The entry permit may also include

- a record of the hazard assessment
- the hazard control plan
- the training records.

See pages 198-200 for a sample of an entry permit form.

Unauthorized entry

The constructor must ensure that each entrance to the confined space is secured against unauthorized entry and/or has adequate barricades or signs warning against unauthorized entry.



RECORD KEEPING

The employers must keep records of every

- ✓ plan
- ✓ assessment
- ✓ coordination document
- ✓ training
- ✓ entry permit
- ✓ record of rescue equipment inspection
- ✓ record of tests.

The records must be kept for at least one year after the project is finished, and they must be available for inspection.



See pages

- 196-197 for a decision tree for confined space entry
- 198-200 for a sample confined space entry permit.

DECISION TREE FOR CONFINED SPACES

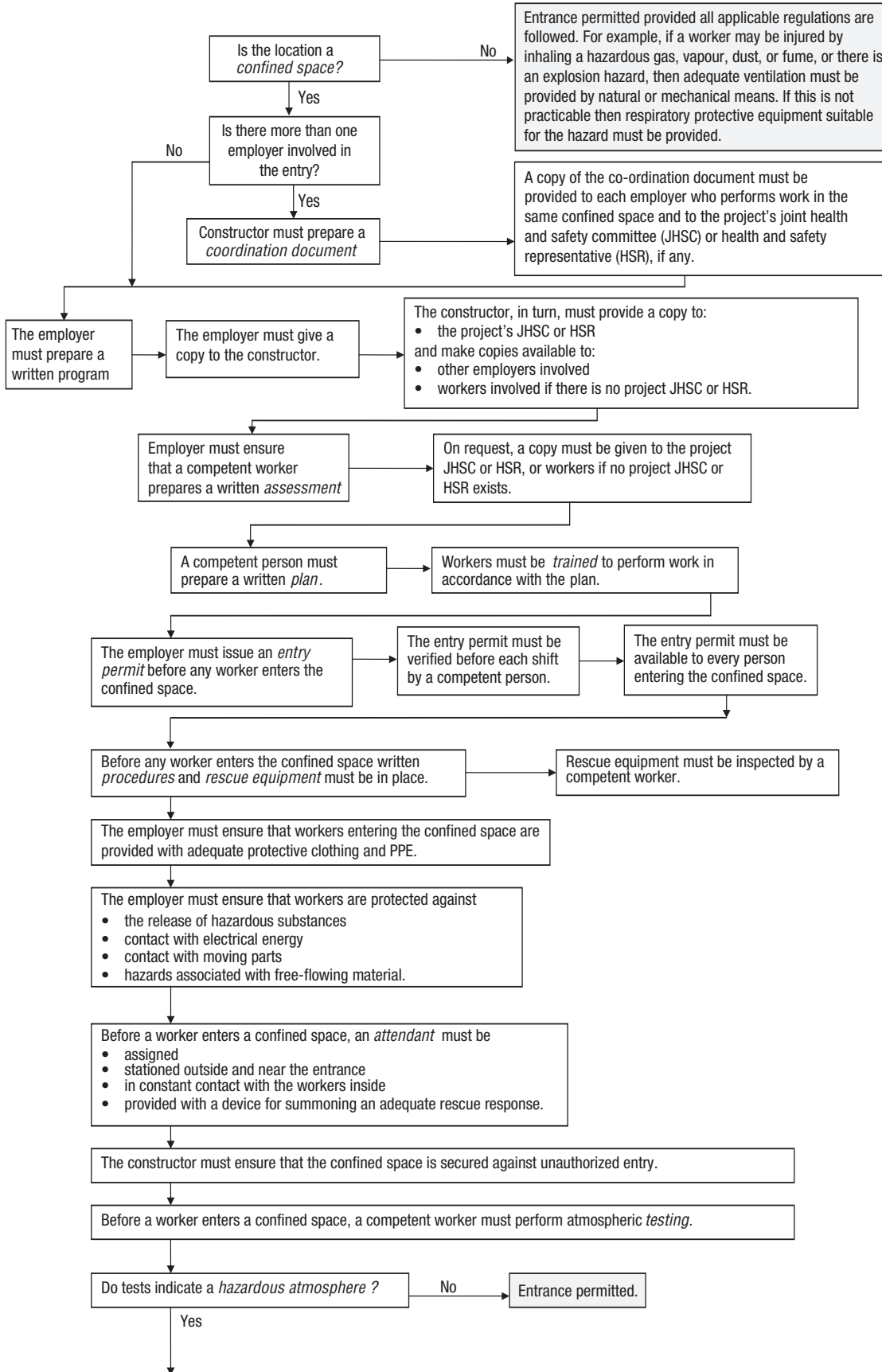

To next page

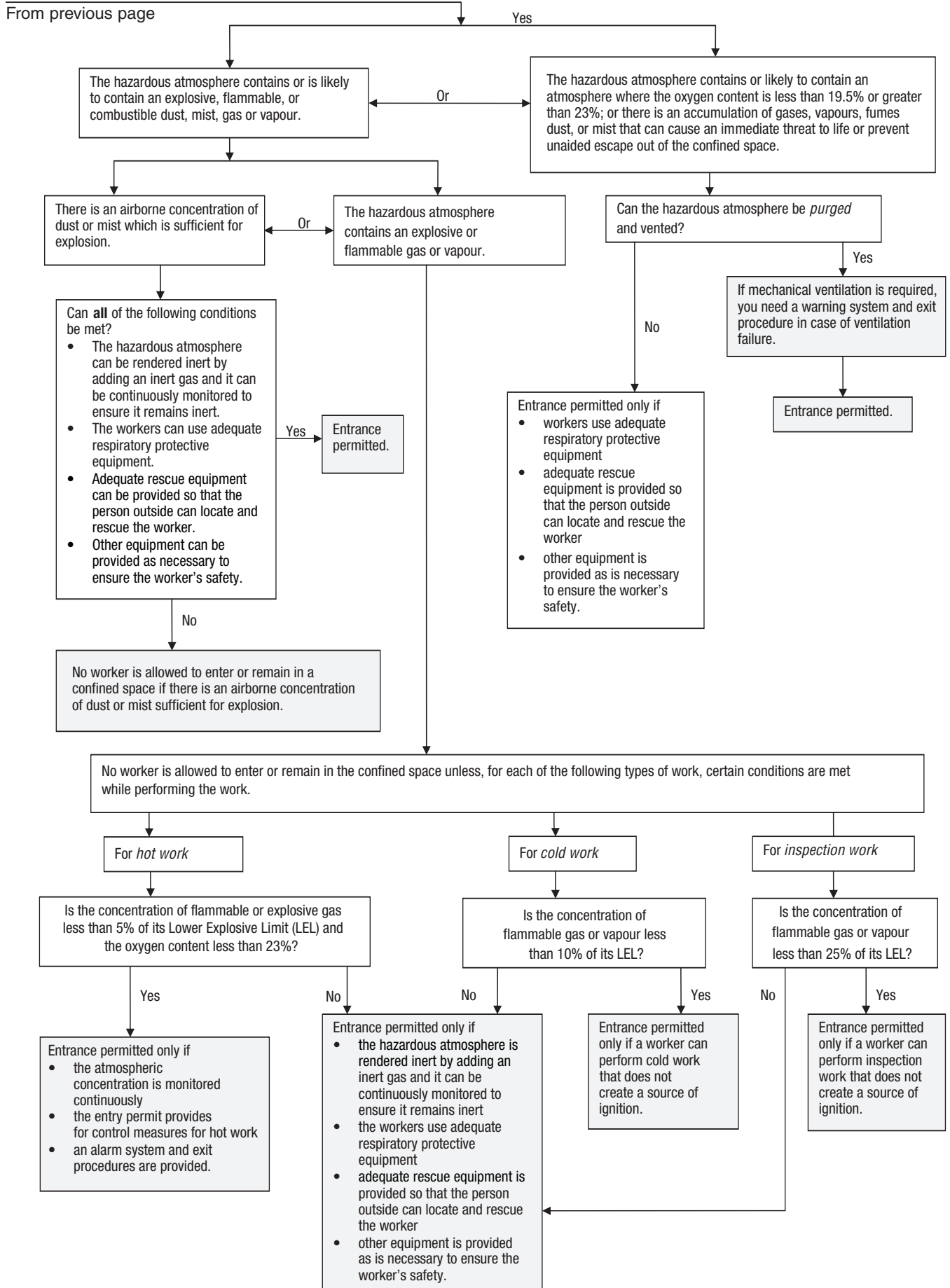

Sample confined space entry permit

Employer name _____ Project name _____

Date _____ Permit end time _____

Assessment performed by _____ Permit start time _____

Location of confined space (or spaces if they are similar)
Description of confined space (or spaces if they are similar)
Description of work to be performed

Monitoring equipment

Air testing equipment	Serial #	Last calibrated

Air quality results

	Location:			Location:			Location:		
	1	Test # 2	3	1	Test # 2	3	1	Test # 2	3
Time of test									
Oxygen, %									
Combustibles, %									
Atmospheric hazard:									
Atmospheric hazard:									
Atmospheric hazard:									
Other:									
Tester's name _____ Signature _____									

Controls

Atmospheric hazards (existing or introduced)		Hazard controls		Personal protective equipment (type)
Flammable	<input type="checkbox"/>	Purge using mechanical ventilation equipped with warning device in case of failure.	<input type="checkbox"/>	Respirator _____
Toxic	<input type="checkbox"/>			Other: _____
Corrosive	<input type="checkbox"/>	Natural ventilation (re-test / air quality)	<input type="checkbox"/>	Gloves _____
Oxygen deficient	<input type="checkbox"/>			Boots _____
Oxygen enriched	<input type="checkbox"/>			Coveralls _____
Other: _____	<input type="checkbox"/>	Continuous monitoring	<input type="checkbox"/>	Eye protection _____
		Other: _____	<input type="checkbox"/>	Other: _____

Physical hazards		Hazard controls		Personal protective equipment (type)	
Hot temperature	<input type="checkbox"/>	Ventilation	<input type="checkbox"/>	Hearing protection	<input type="checkbox"/>
Cold	<input type="checkbox"/>	De-energize, lockout	<input type="checkbox"/>	Anti-vibration gloves	<input type="checkbox"/>
Noise	<input type="checkbox"/>	Blank, disconnect	<input type="checkbox"/>	Other gloves: _____	<input type="checkbox"/>
Electricity	<input type="checkbox"/>	GFCI cords	<input type="checkbox"/>	Goggles	<input type="checkbox"/>
Vibration	<input type="checkbox"/>	Lighting	<input type="checkbox"/>	Fall protection	<input type="checkbox"/>
Slippery surface	<input type="checkbox"/>	Other: _____		Other: _____	<input type="checkbox"/>
Lighting	<input type="checkbox"/>				
Work at height	<input type="checkbox"/>				
Moving machinery	<input type="checkbox"/>				
Influx of liquid	<input type="checkbox"/>				
Influx of gas	<input type="checkbox"/>				
Hazard above	<input type="checkbox"/>				
Other: _____					

Attendant

Attendant's name _____	Signature _____
------------------------	-----------------

Communications

Method of communication with workers _____	Method of communication to summon rescue _____
---	---

On-site rescue

Adequate number of trained persons are available to implement rescue procedures	<input type="checkbox"/>
---	--------------------------

Appropriate rescue equipment is readily available to be used for a rescue	<input type="checkbox"/>	Appropriate rescue equipment has been inspected and is in good working order:	<input type="checkbox"/>
List of equipment required for entry		<input type="checkbox"/> Respirator	<input type="checkbox"/> Coveralls
Tripod <input type="checkbox"/> Harness <input type="checkbox"/> Winch/cable <input type="checkbox"/> Other: _____			

Training

Names of workers approved for entry	Has confined space training	Trained in the entry plan	Time of entry	Time of exit

Hot work (complete if hot work will be conducted)

Will space be rendered inert by adding inert gas? Yes No

If "yes," ensure

- space is monitored continuously to ensure it remains inert
- worker(s) entering use adequate respiratory equipment – list equipment: _____
- there is adequate equipment to allow persons outside to locate and rescue worker – list equipment: _____
- there is other equipment necessary to ensure safety of worker – list equipment: _____

If "no," ensure

Flammable gas is maintained below 5% of its LEL by purging and continuous ventilation	O ₂ content is maintained below 23%	Atmosphere will be monitored continuously	Alarm and exit procedures are in place should the LEL exceed 5% or the O ₂ exceed 23%
<input type="checkbox"/>	<input type="checkbox"/>	<input type="checkbox"/>	<input type="checkbox"/>

Supervisor's name _____

Signature _____