

- use, maintenance, and limitations of personal protective equipment.

The effectiveness of health and safety training should be periodically evaluated through

- a workplace inspection to ensure that safe working procedures, equipment, and conditions are implemented.
- air monitoring of common contaminants to determine the effectiveness of controls and compliance with acceptable limits.
- an assessment of control performance (for instance, testing of the ventilation system)
- review of lost-time-injuries
- discussion of the program with the health and safety committee or representative(s).

Any corrective actions necessary should be taken immediately.

7 FORMWORK

Glossary

The following definitions are used in the forming industry. Some terms may be used by other trades as well, but their meanings may be different from these depending upon the application.

Falsework, in relation to a form or structure, means the structural supports and bracing used to support all or part of the form or structure.

Flying formwork is a designed system which can be hoisted between levels as a unit.

Forms are the moulds into which concrete or another material is poured.

Formwork is a system of forms connected together.

Gangforms are large panels designed to be hoisted as a unit, and to be erected, stripped, and re-used.

Knock-down forms are traditional formwork supported by falsework and shoring, assembled from bulk materials, used once, and then dismantled.

Panels are sections of form intended to be connected together.

Sheathing is the material directly supported by wales, and against which concrete is to be placed.

Specialty formwork is designed specifically for a particular structure or placing technique.

Struts are vertical members of shoring that directly resist pressure from wales.

Wales are horizontal members of shoring that are placed against sheathing to directly resist pressure from the sheathing.

General

In most cases, the formwork required for concrete construction is built by carpenters. Shoring and bracing support the forms that contain the wet concrete. Formwork must also support the temporary weight of material such as bundles of reinforcing steel and live loads of workers and equipment.

There are three stages in formwork operations:

- assembly and erection
- concrete placement
- stripping and dismantling.

To be done safely, each of these jobs requires planning, knowledge, and skill from both supervisors and workers. Design and planning are a supervisory function that may also legally require a professional engineer's involvement. Small construction and renovation jobs, however, sometimes call for design on site by workers.

Where design drawings are provided, it is important to construct the formwork as designed. Any confusion regarding the design should be cleared up with the designer.

If site conditions require changes or the design does not seem to suit the situation, clarification should also be obtained from the designer. Formwork failures frequently involve deviations from the original design that were done without consulting the designer. They may also involve human error. For these reasons, formwork and shoring must always be inspected before concrete is placed.

All large formwork installations in Ontario must be designed by a professional engineer. But there are always smaller jobs of moderate height or depth – basements, footings, stairs – that may include formwork designed and constructed on the site.

Every carpenter should therefore know the type of formwork needed and how to build, install, and dismantle it safely.

Formwork must always be constructed according to good, safe, and sound carpentry practice. There must be

- adequate braces and supports
- reliable bearing surfaces, especially where wood structures are involved
- adequate ties, bolts, or bracing to prevent movement or bulging.

Because wood is relatively soft, it will crush under heavy loads such as concrete when the bearing surface of joists on stringers, or studs on wales, is not adequate.

Crushing can be avoided by increasing the bearing area between members, using spreader washers (Figure 189), or increasing the number of joists or studs.

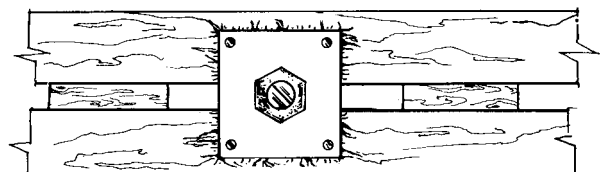

Figure 189
Spreader Washer on Wooden Wale System

Hazards

The following are the main hazard areas in formwork operations.

- **Falls** – They are the major hazard because they are **potentially fatal**. Cramped work areas, inadequate access, failure to install guardrails, failure to use fall-arrest systems, tools or material left underfoot, and surfaces slippery from form oil can all lead to falls. Ladders are also frequently involved in falls. Workers must have fall protection whenever they are exposed to the risk of falling more than 3 metres, or falling from any height into dangerous machinery, substances, or objects such as rebar. In some circumstances, you must use fall protection when the height is 2.4 metres (8 ft.) or more. (See chapter on Guardrails.)
- **Materials handling – The activity most frequently connected with injury.** Improper or excessive materials handling can result in sprains, strains, and overexertion in shoulders, arms, and back, as well as bruises, abrasions, and crushed fingers.
- **Struck against** – Common because formwork operations are constantly changing and involve the movement of heavy, awkward, and pointed components. Wales, beams, panels, snap-ties, nails, bolts, and rebar can cause punctures, cuts, contusions, and abrasions.
- **Struck by** – Another common cause of injury. Rebar, formwork panels, concrete buckets, and other material hoisted overhead can strike workers. Struck-by injuries can also be caused by hammers, pry bars, stakes, wedges, and material such as joists and panels during stripping.
- **Electrical contact** – Power tools, extension cords, and temporary supply and wiring systems, used under less-than-ideal conditions – mud, ground water, wet excavations, fresh concrete – can lead to ground faults, shortcircuits, and shock hazards. Ground fault circuit interrupters are legally required for portable tools used outdoors or in wet locations.
- **Collapses** – Even with advanced methods of design and installation, there is always the risk that formwork, slabforms, wall forms, and other large components can come loose, slip out of place, or fall over, striking or crushing workers underneath.
- **Health hazards** – The spraying of form oils and curing compounds can irritate the lungs. Contact with these chemicals can irritate the skin, leading to redness, inflammation, or dermatitis. The same conditions can result from the abrasive/corrosive effect of skin contact with concrete or cement, especially when inadvertently left inside boots all day.
- **Environmental conditions** – Ice, snow, and rain create slippery conditions. Wind can be a major hazard. Handling sheets of plywood becomes more difficult, panels may require more bracing, and hoisting gets harder, especially with large panels or tables.
- **Dust and concrete** – Blowing dust and flying concrete particles during the chipping or cleaning of formwork can injure unprotected eyes.

- **Access equipment** – Access equipment such as ladders and scaffolds is involved not only in falls but in slips, trips, and other accidents. Hazards include ladders not tied off, workers carrying materials while climbing, ladders obstructed at top or bottom, scaffolds not completely decked in, and scaffolds erected or dismantled without fall protection.
- **Lighting** – Inadequate lighting can create or aggravate hazards when workers install or strip forms in dark areas or place concrete at night.

Injuries

Formwork hazards can lead to the injuries – and be prevented by the measures – described below.

- **Eye injuries** – These are quite prevalent in formwork operations. Most result from particles of wood or concrete that fall or are blown into the eye during chipping and cleaning. The injuries may not be severe but most can be prevented by wearing eye protection. It is strongly recommended that everyone on site wear eye protection at all times.
- **Cuts, scrapes, punctures** – The manhandling necessary to install and strip formwork can lead to cut hands, arms, and legs, as well as pinched or crushed fingers. Gloves help to prevent injuries from rough or sharp edges on formwork components. But workers must also have the knowledge, skill, and physical ability necessary for safe materials handling. That means knowing your limitations and asking for help when needed. Formwork involves protruding objects such as nails, snap ties, conduit, and bolts that can give you cuts and punctures. Where possible, these objects should not be left sticking out or should be covered over.
- **Back injuries** – These injuries are frequently related to materials handling. The most important preventive measure is back care. Exercise programs, warm-ups before work, and knowing your limitations can help to prevent sprains and strains. Wherever necessary, get help or use dollies, carts, or other mechanical devices.
- **Ankle sprains and fractures** – Working in close quarters, stepping over debris and material, climbing into excavations, turning with awkward loads, jumping down from scaffolds or benches — these can lead to ankle and other foot or leg injuries. Prevention starts with proper housekeeping and materials handling.
- **Bruises and contusions** – Handling formwork under rushed, cramped, or slippery conditions or beyond your limitations can lead to bruises. Bruises and contusions also result from contact with protruding formwork components. More serious are contusions from falling formwork materials. Formwork must be braced to ensure stability, especially under windy conditions. Try to avoid areas where work such as hoisting or stripping is being done overhead.
- **Fall injuries** – All of the injuries above, and many others, can result from falls. Most falls are caused by missing or inadequate guardrails, failure to use fall-arrest equipment, failure to completely plank scaffolds and other work platforms, and standing or climbing on

surfaces not meant to be used as such – the tops of wall forms or 2 x 4 wales, for example. Installing and stripping formwork often requires the use of a fall-arrest system.

Falls also result from holes left unguarded or uncovered in formwork. These should be covered up or fitted with guardrails as quickly as possible. Where this cannot be done, the area should be roped off and posted with warning signs to prevent unauthorized entry.

Planning

Planning is the first and most important step in reducing hazards and preventing injuries.

Because formwork operations must often be carried out in congested areas where other trades are also working, planning is essential in making the most of the time and space available to improve safety and efficiency.

Planning is a must for fall protection, work platforms, material staging areas, housekeeping, and material handling and movement.

Planning should take place at every level from manager through supervisor to worker. Planning labour, materials, equipment, and work schedules to meet design requirements is the responsibility of management and supervision.

Workers must plan the details of their assigned tasks based on the most effective work methods and safety measures to follow in each case.

Design

Safety and economy are the main factors in design. Both have to be considered because adjustments in one affect the other.

For example, reducing the support structure for wall forms in expectation of reduced pouring rates should not be considered if the rate of pour is not going to be controlled on the job.

Fresh concrete exerts a pressure on formwork similar to liquids. However, concrete starts to set when poured so that

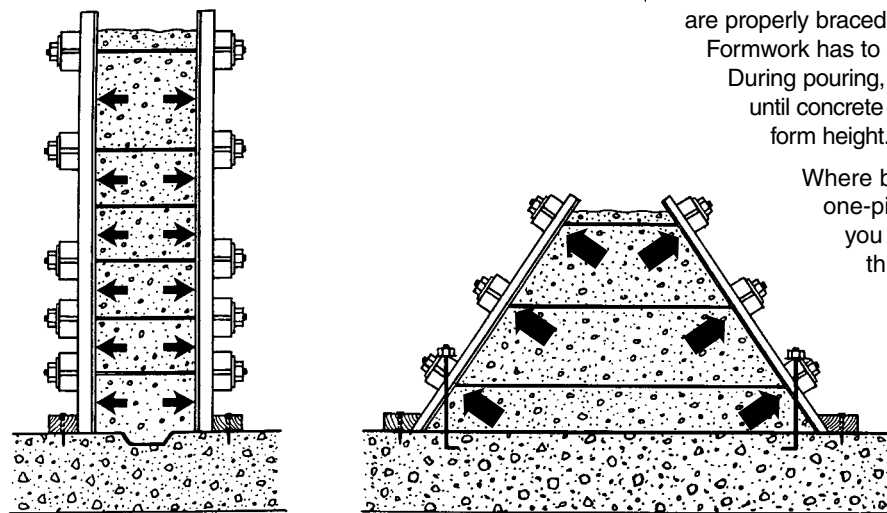

Figure 190 — Pressure of Concrete on Vertical and Battered Formwork
(Note expansion anchors holding down battered form.)

if the pour rate is slow the maximum pressure can be reduced, since concrete at the bottom will be set before concrete at the top is poured. Similarly, if the forms are filled to the top immediately, they must be able to withstand the pressure of the full liquid head. Liquid concrete exerts a minimum pressure of 150 pounds/foot² times the height in feet.

Other factors determine how long concrete will remain liquid, such as temperature, slump, vibration, and admixtures. For example, concrete will set much more quickly in hot summer weather than in cold winter weather. As a result, the same form filled at the same pour rate may be subjected to greater pressure in winter than in summer.

Concrete pumping may cause additional pressure, as well as vibration, on forms and must be considered at the design stage. The action of the pump sends surges of pressure through the piping system which are often transmitted directly to the forms, especially for narrow walls or columns. Vibration may move the forms or loosen bracing, ties, or spreaders.

Pressure acts perpendicular to formwork surfaces (Figure 190). This causes an outward thrust for typical wall or column forms. However, it can also cause uplift for battered or sloping forms. These require hold-down anchors or tie-down braces. The anchors will prevent the forms from lifting up or floating on the concrete.

Consider using bracing systems and spreaders for wall forms. Concrete filling the bottom of the form may cause forces at the top to push the two sides together unless they

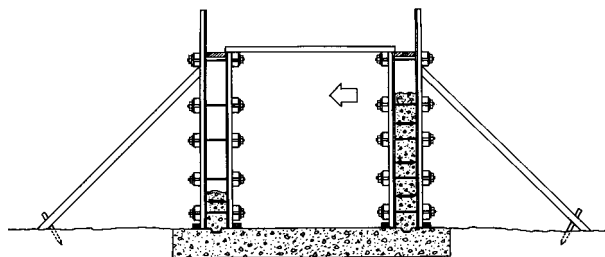

Figure 191

Open-cut tunnel formwork with bracing and spreaders on each side

are properly braced and/or separated with spreaders.

Formwork has to be designed to resist such forces.

During pouring, ensure that spreaders are not removed until concrete has reached at least two-thirds of the form height.

Where box forms are used – for instance, on one-piece covers for open-cut tunnels – you must use bracing against the side thrusts caused by the uneven pouring rates of the walls. Resisting these forces requires that the system be tied together and securely braced (Figure 191).

Formwork should be designed and constructed with stripping and removing as well as pouring in mind. On wooden forms, crush plates or filler strips should be used at corners such as slab-and-column or slab-and-wall

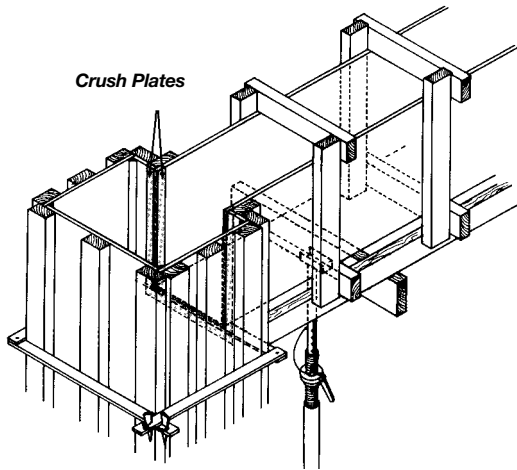

Figure 192 — Crush Plates

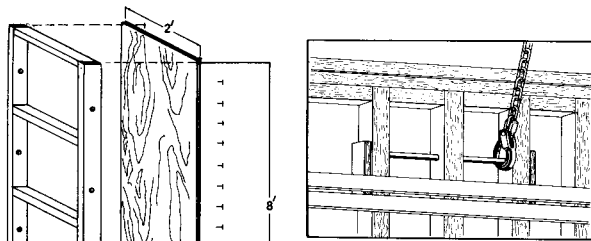

Figure 193 — Formwork Panel

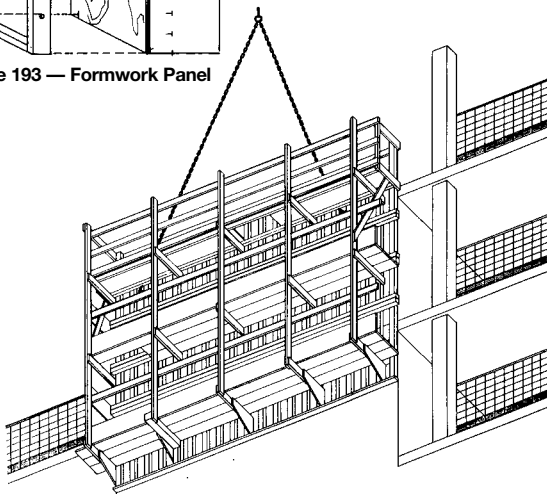

Figure 194 — Formwork Lifted as Single Unit

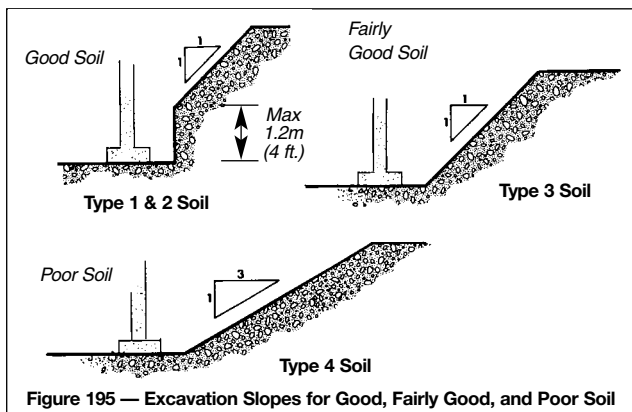

Figure 195 — Excavation Slopes for Good, Fairly Good, and Poor Soil

intersections (Figure 192). The plates or strips are easily removed with a wrecking bar and, once removed, make the stripping of adjacent panels much easier.

The strips should be big enough to leave space at the edges of the panels to accommodate wrecking bars.

When formwork has to be manhandled during assembly or dismantling, the design should ensure that the components are manageable. Formwork panels are not only heavy but awkward (Figure 193). Realistic design demands consideration of the size as well as the weight of panels.

A formwork panel or wall form to be lifted as a single unit must be designed to withstand the loads and forces exerted by hoisting (Figure 194). In most cases, this means designing a more substantial structure. Fastening components may also need more attention at the design stage. For example, simple nailing may not be enough to hold plywood sheets.

Special attention must also be applied to the design, construction, and use of pick points for hoisting. The strongbacks and wales must be securely attached to the formwork. The pick points must be located so that the panel hangs properly during installation, concrete placement, and removal.

Types of Formwork

Below Grade

The first concern with formwork below grade is the stability of the excavation walls. Walls must be either shored or sloped according to soil type as defined by the Construction Regulation (O.Reg. 213/91). Figure 195 shows typical slopes.

In most cases the shoring must be designed by an engineer. Engineers may also specify slopes for excavations. In both instances the design drawings must be kept on the project.

Excavations should be kept essentially dry. Water should be pumped out. Mud should be cleared off and replaced by compacted granular material in work areas and on surfaces where concrete will be placed. Mud presents slipping hazards and can lead to interior construction if not removed or replaced.

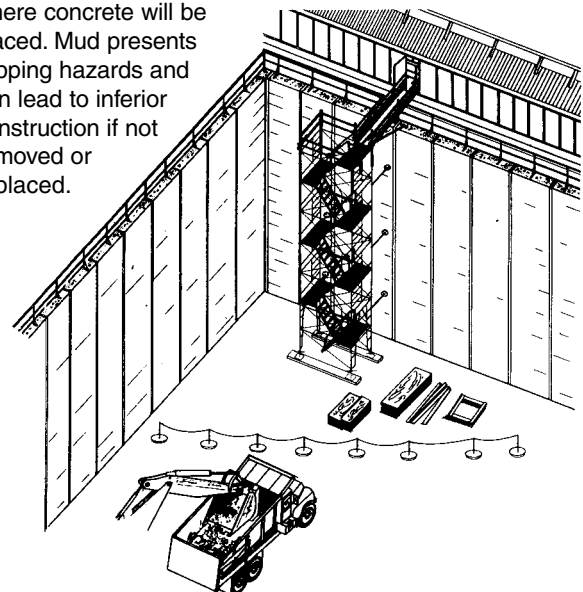

Figure 196
Formwork Roped-Off from Other Operations

Since mud has to be removed before concrete is placed, it might as well be removed before formwork is constructed, thereby reducing slipping hazards at both stages.

Water and mud also contribute to electrical hazards. Grounding and insulation must be effective and intact. Ground fault circuit interrupters (GFCIs) are required by law on all portable tools used outdoors or in wet locations.

Formwork for footings and grade walls frequently begins before excavation in the area is complete. Trucks and excavating equipment put workers on foot at the risk of being struck down or run over.

Wherever possible, formwork operations should be roped off from other work such as excavation or pile-driving (Figure 196). Separate access ramps for vehicles and workers are strongly recommended.

Stairs are an even better alternative for personnel on foot.

Mud sills must be used to support any shoring or bracing that rests on soil in the excavation (Figure 197). The sill must bear on the soil throughout its length. Sills should not be used to bridge holes or irregular surfaces. To ensure uniform bearing, soil should be levelled before sills are set in position.

The soil must have the capacity to bear whatever loads are applied. This information may or may not be on the design drawings.

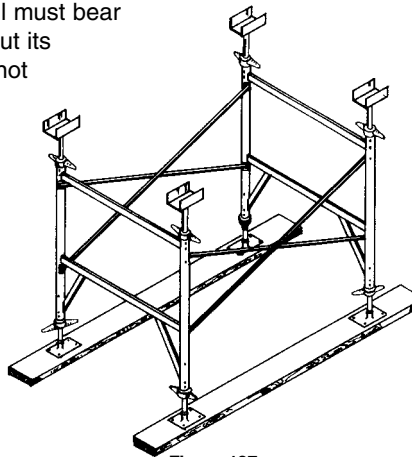

Figure 197
2" x 10" Mud Sills Under Shoring Frames
Good Soil Bearing Capacity – Moderate Load

In Situ Bearing Pressure for Dry Soil Conditions (Conservative Estimates)

Silt and clay	1200 lbs/ft ²
Sands	4000 lbs/ft ²
Gravelly sands	6000 lbs/ft ²
Gravel	8000 lbs/ft ²

Soil that supports bracing or shoring should be compacted and qualify as good soil at least (cohesive, hard, with no water). Professional advice is recommended and may be required for heavy structures such as elevated equipment supports shored at or below grade.

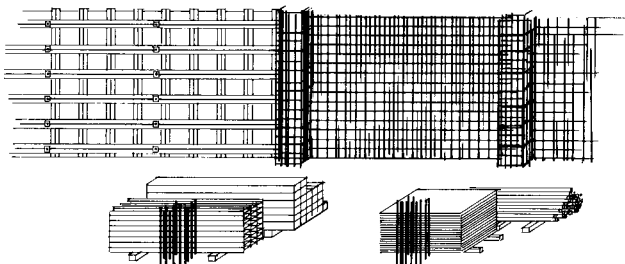

Figure 198
Well-Planned Storage, Access, and Setup

Formwork in these situations is frequently built in place. Planning is required to store material and equipment out of the way, dispose of scrap and debris, and ensure safe, efficient access (Figure 198). Because conditions are often cramped and scrap accumulates quickly, it is important to clean up as work proceeds.

Wall Forms

Wall forms built in place are hazardous to construct. Hazards include

- dowels sticking up from concrete slabs or footings
- unstable work surfaces and access created by poor planning
- manual handling of heavy material such as plywood sheets, panels, wales, and buckets of snap-ties, wedges, and plates
- slippery surfaces at and below grade
- inadequate design
- improper construction.

The best protection against dowels is a wood cover built of lumber at least 1-1/2 inches thick and wired in place (Figure 199).

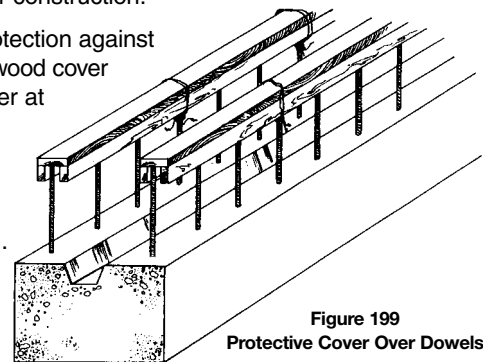

Figure 199
Protective Cover Over Dowels

Starting the Form

Setting up the first form is always hard, heavy, manual work. It calls for enough workers to do the job without overexertion or injury.

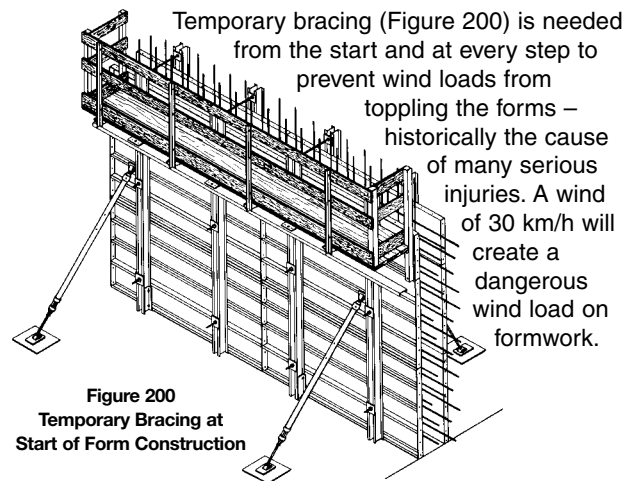

Figure 200
Temporary Bracing at Start of Form Construction

Temporary bracing (Figure 200) is needed from the start and at every step to prevent wind loads from toppling the forms – historically the cause of many serious injuries. A wind of 30 km/h will create a dangerous wind load on formwork.

Access to wall forms is not always given enough thought. Forms more than 2 metres high will require access platforms for workers involved in concrete placing. The platforms can also be used to complete the upper portion of the formwork.

An alternative is a frame scaffold, which can also be used to install reinforcing steel (Figure 201).

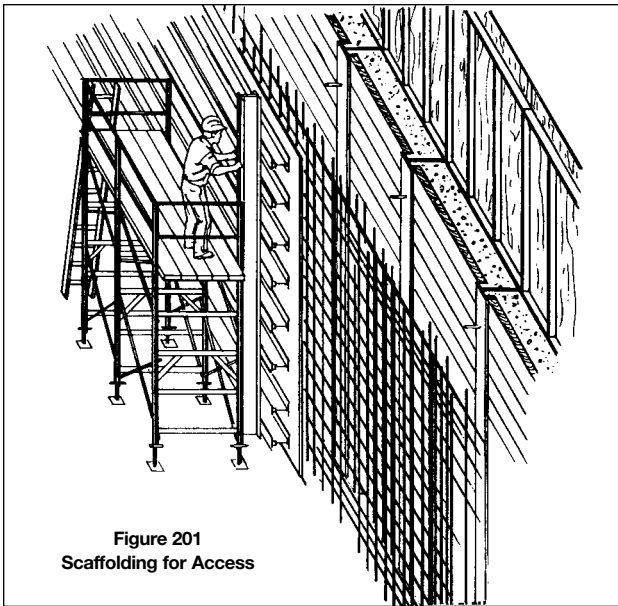

Figure 201
Scaffolding for Access

Fall-arrest systems or scaffolds with guardrails must be used where workers may fall more than 3 metres (10 feet), or onto hazards such as projecting dowels (Figure 202). In some circumstances, you must use fall protection when the height is 2.4 metres (8 ft.) or more. (See chapter on Guardrails.)

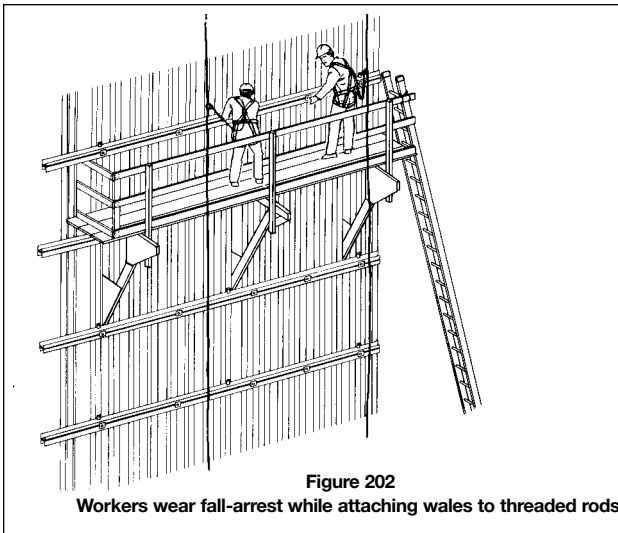

Figure 202
Workers wear fall-arrest while attaching wales to threaded rods.

Materials should be distributed along the work location to minimize further handling. But traffic and work areas must be kept clear for the safe movement and installation of material.

Form Construction

Wall forms must be constructed as designed. The design must indicate clearly what is required.

Some wall forms are designed for specific concrete placement rates expressed in metres of height per hour (m/hr). A wall form in which concrete is placed to a height of one metre in one hour would have a placement rate of 1 m/hr. Slower pouring rates result in lower formwork pressure because the bottom concrete has started to set.

Ensure that ties and braces are installed where indicated on design drawings. Ties should be snugged up. Braces

should be securely fastened to forms and wedged or fastened to a support that will not settle or deform under load (Figure 203).

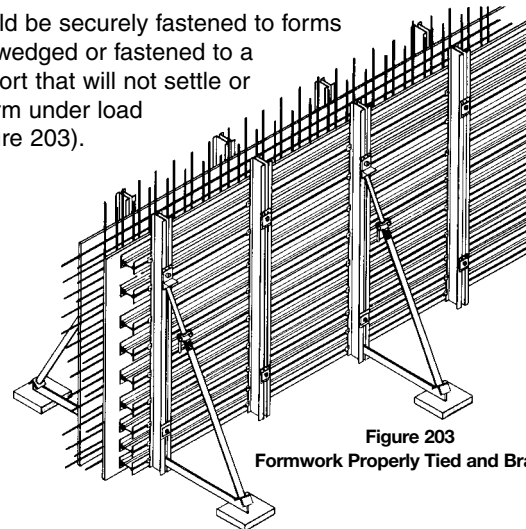

Figure 203
Formwork Properly Tied and Braced

Formwork platforms must be

- capable of bearing at least 50 pounds/foot²
- adequately supported
- equipped with guardrails
- secured at the level or levels where work such as pouring and stripping will be done.

Recommended design pressures for various pour rates and environmental conditions are set out in CSA Standard S269.3 *Concrete Formwork*. The standard defines a number of other design considerations and should be consulted by field staff.

Slab Forms or Falsework Built in Place

With slab forms built in place the major hazard is falls. Injuries are also connected with the manual handling of heavy materials and components.

Forms built in place usually have to be taken down in place. This should be considered at the construction stage. Stability may also be a consideration where the structure is high, carries heavy loads, and is placed on grade as in bridge and overpass construction.

Fall protection is difficult to provide for workers building slab forms in place. That's why planning is essential in the design and erection procedure.

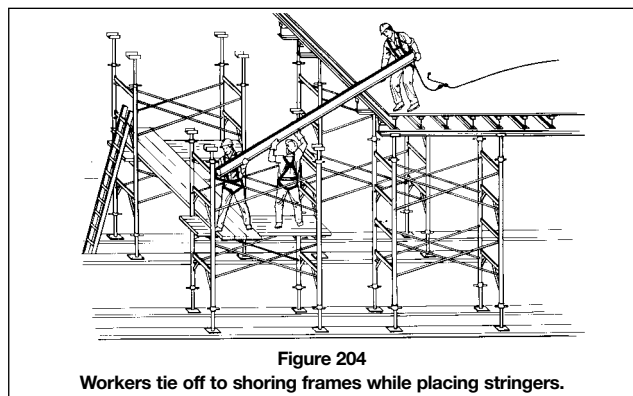

Figure 204
Workers tie off to shoring frames while placing stringers.

Workers should wear a safety harness with the lanyard tied off to the structure of the formwork (Figure 204). This means tying off to the support structure where shoring frame structures are being constructed, tying off to a lifeline when placing plywood panels at a leading edge, constructing a

guardrail at the edge of the formwork, or tying off to the support structure when tying it together with tube and clamp. Don't wait for the structure to be completed before tying-off. Make sure you have fall protection at all stages of formwork construction.

Wherever possible, cranes or other equipment should be used to move material, thereby reducing the amount of manual carrying, lifting, and handling.

Shoring towers require special consideration.

- Towers must remain stable during construction and dismantling. Guys may be necessary to maintain stability (Figure 205).

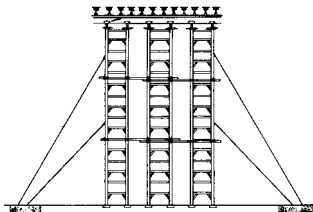

Figure 205
High Guyed Towers

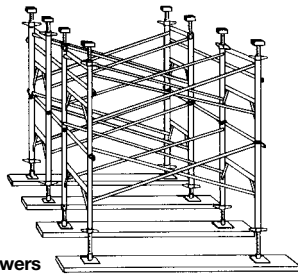

Figure 206

Tube-and-Clamp Tie-Ins for Shoring Towers

- If towers are to be tied together and braced horizontally, this should be done as work progresses (Figure 206).
- Shoring towers and shores should be installed so they are plumb to within 1/8 inch in 3 feet.
- Shoring towers should be snugged up under the stringers with adjustable base plates and U-heads (Figure 207).
- If frames do not ride tightly on top of one another after tightening, one or more are out of square and should be replaced (Figure 208).

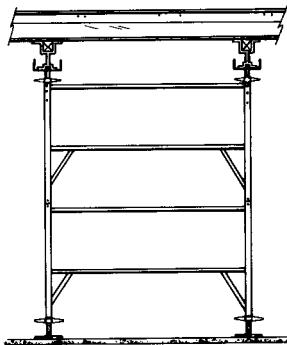

Figure 207

Typical Shoring Tower with Stringers, Adjustable Base Plates, and U-Heads

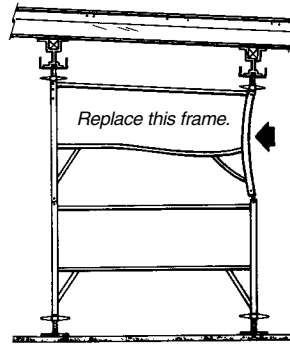

Figure 208

Frame Bent Out of Shape

- With single-post shores, provide adequate lateral bracing (Figure 209). Stairwells and balconies are places where horizontal bracing for single-post shoring systems may be required.

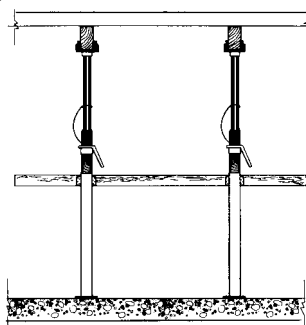

Figure 209

Single-Post Shores with Lateral Bracing

Frequently, supports for built-in-place forms are

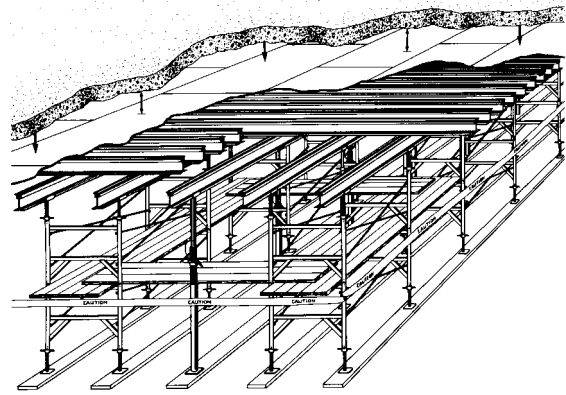

Figure 210

Two Rows of Shoring Frames with Row of Shoring Posts in Centre

deliberately left out to allow other work to be done. One example might be a row of single-post shores left out until work below is complete. Or, an area might be supported temporarily during construction by a few single-post shores that will be replaced later by a shoring tower.

In these and other instances of incomplete formwork, heavy temporary loads such as bundles of rebar or stacks of plywood should not be placed on the structure. Even on completed formwork, make sure that landed material will not overload the structure.

Flying Forms

Flying forms must always be designed by a professional engineer and constructed, hoisted, moved, and set strictly according to the instructions of the designer or manufacturer.

Using forms designed for typical floors in non-typical situations has resulted in serious accidents. Before using any flying form under non-typical conditions, consult the designer or manufacturer. Wall forms should not be extended in height or width, for instance, or slab panels cantilevered without professional consultation. Such situations usually occur with penthouses or mechanical rooms where wall and ceiling heights are greater than for typical floors.

Apart from misuse, hazards with flying forms include

- stability during initial fabrication
- fill-in work between slab panels
- stripping, flying, and re-setting.

In the last category especially, falls are a common hazard.

For fall protection, see the next section.

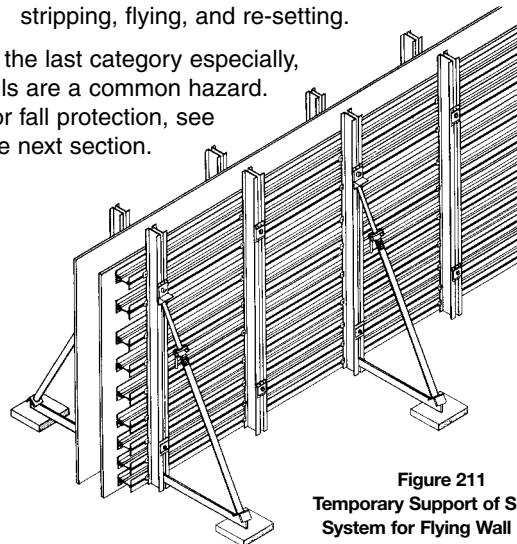

Figure 211

Temporary Support of Shoring System for Flying Wall Form

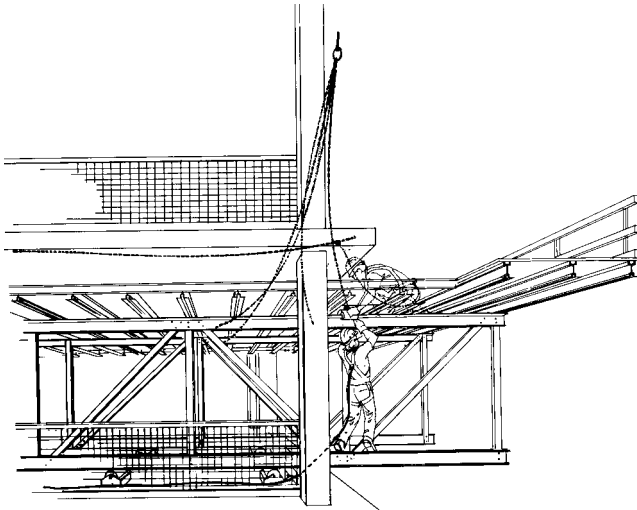
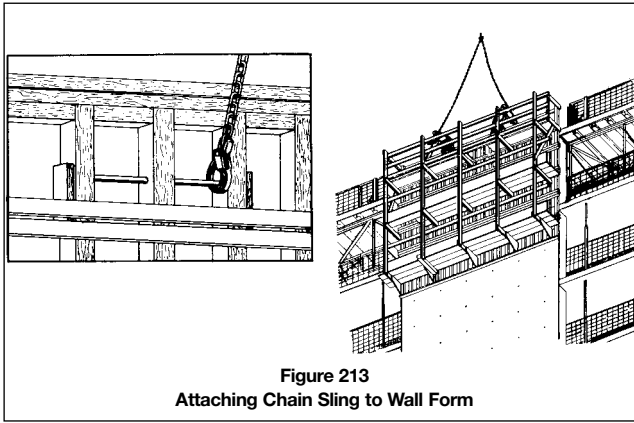

Figure 212 — Helping Worker Above



**Figure 213
Attaching Chain Sling to Wall Form**

Fall Protection — Flying Forms

A fall-arrest system should be used by any worker who is

- installing
- pushing a panel out toward the slab edge
- receiving a panel in from the slab edge
- helping other workers attach rigging hardware such as slings (Figure 212)
- getting on and off
- bolting and unbolting wall forms for exterior walls and elevator shafts (Figure 213)
- stepping onto a panel to attach slings to pick points (Figure 214).

Each worker's fall-arrest system must be attached to an individual anchor independent of the flying form. Contractors can provide for anchorage by casting rebar anchors in columns or other areas to be covered over or filled in later (Figure 215).

Safety Below Flying Forms

The previous section covered the safety of workers flying the forms. But precautions must also be taken to protect workers below the hoisting operation and the public at large, since forms are often swung out over sidewalks and streets. The most efficient protection for workers is to rope off the area below to prevent anyone from entering the area. Pedestrian traffic on sidewalks, as well as vehicle traffic if necessary, should be detoured around the area while hoisting is under way.

Communication

Flying forms are heavy, large, and awkward. To hoist and move them safely requires clear reliable communication. While hand signals are often necessary, direct radio

Although a flying form is designed to be stable when complete, it may not be stable during fabrication or erection. Temporary bracing or temporary support by a crane may be necessary to ensure stability during certain phases of the operation (Figure 211).

One example is setting up trusses for a flying slab formwork table. The trusses must be held upright to be connected or disconnected. If not adequately supported, they can fall over on workers. Trusses and wall panels have also been blown over by wind during fabrication and dismantling.

Work with flying forms requires adequate space for stacking materials and components. Working in cramped quarters is not only difficult but hazardous.

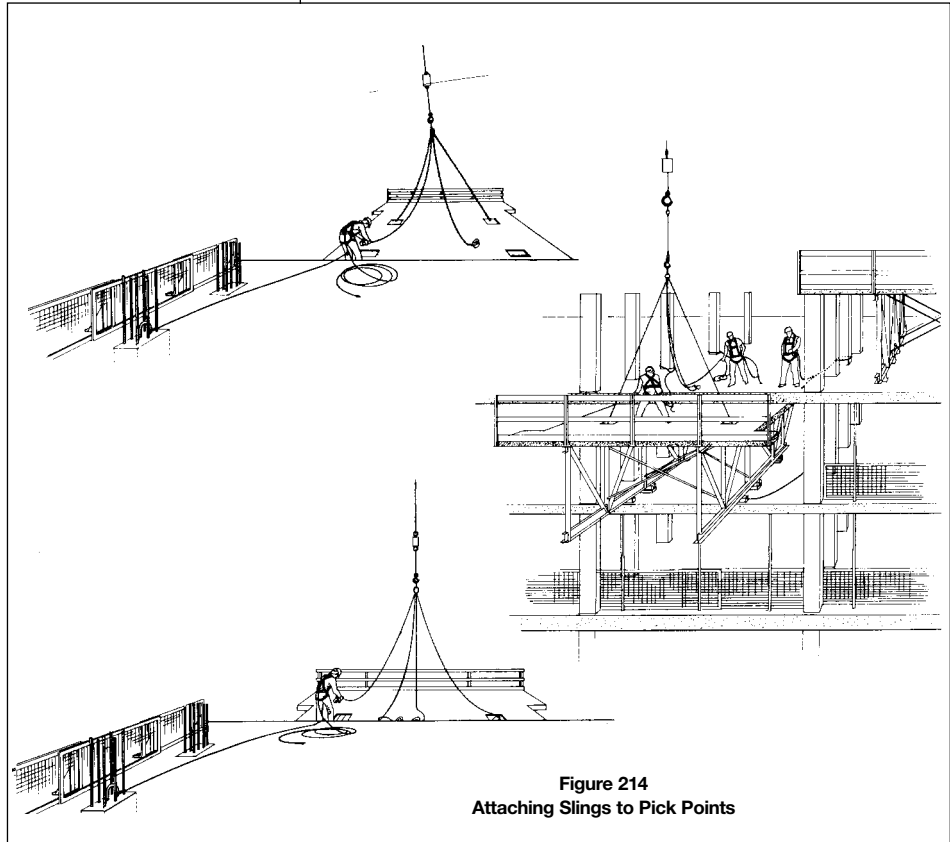

**Figure 214
Attaching Slings to Pick Points**

communication between work crew and crane operator is more accurate and effective. Relying on hand signals alone is not recommended.

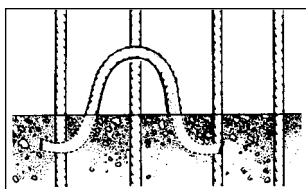

Figure 215
Rebar Anchor Cast in Concrete

Stripping

General

Formwork stripping is probably the most hazardous operation in concrete construction. Hazards include

- falling material
- material and equipment underfoot
- manual handling of heavy or awkward forms, panels, and other components
- prying forms loose from concrete presents risk of overexertion, lost balance, and slips and falls.

Hazards can be reduced by

- planning and providing for stripping when designing and constructing formwork
- supplying facilities and equipment for removing materials as they are stripped
- providing proper tools and adequate access for the stripping crew
- training personnel properly for this and other aspects of formwork.

Forms can be designed with crush plates or filler strips to facilitate removal at difficult intersections of columns, beams, and wall forms. Later, form oils should be used liberally to make stripping easier.

Whenever possible, materials and debris should be removed from the area as work proceeds. This will reduce the need to walk over or work around things left on floor or ground.

Providing carts or cradles can help the crew remove material and reduce the need for lifting and carrying. Material on a cart can be rolled away. Material in cradles can be hoisted off by a crane.

Climbing partially stripped formwork is not only hazardous but unnecessary. Safe access such as rolling scaffolds or powered elevating work platforms should be provided for stripping formwork at elevated locations.

Poor lighting is sometimes a hazard in formwork stripping. Mobile light stands are probably the best solution, since pigtail stringers can easily be knocked down and damaged during stripping.

Whenever possible, stripping crews should be small. This is especially important with knock-down systems. In small crews each person can keep track of what the others are doing. Workers are not as likely to cause problems for each other. Crews of two or three are recommended for knock-down systems. If more workers are required, they can still be divided into small crews working in separate areas.

Other trades and operations should not be allowed in areas where stripping is under way. Given the many hazards involved, the area should be roped off and warning signs posted.

Knock-Down Slab Systems

Stripping these forms is difficult because much of the work is overhead. The usual arrangement involves shoring frames or a combination of shoring frames and jacks.

Whenever possible, the work should proceed from one side. That means taking out one row of formwork supported by a row of stringers on shoring frames.

The first step is to back off the adjustable base plates and U-heads in one area, which will in turn lower the stringers, joists, and plywood (Figure 216).

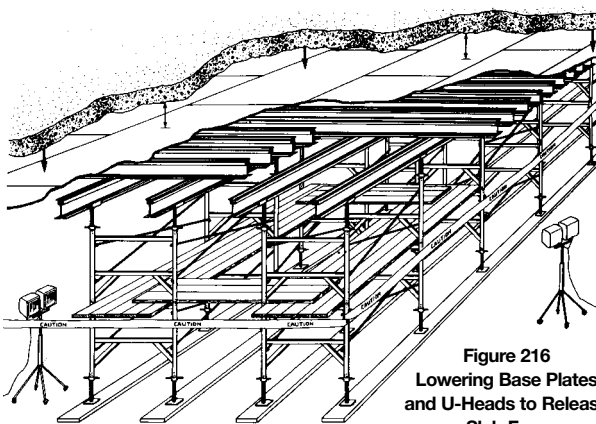

Figure 216
Lowering Base Plates and U-Heads to Release Slab Form

In practice, however, the plywood will stick, especially around beams, column caps, and similar points. Wherever possible, stuck sheets should be loosened and removed before the shoring structure is dismantled.

Stripping should proceed in reverse order to erection. Plywood should be removed first, followed by joists and stringers. The last items to be removed are the shoring frames.

When scaffold or shoring frames are used for access, the platform should be completely decked in with planks (Figure 217). Otherwise planks can shift and slide as workers pry or pull at stuck pieces of formwork, lose their balance, and fall. This has been a frequent cause of injuries.

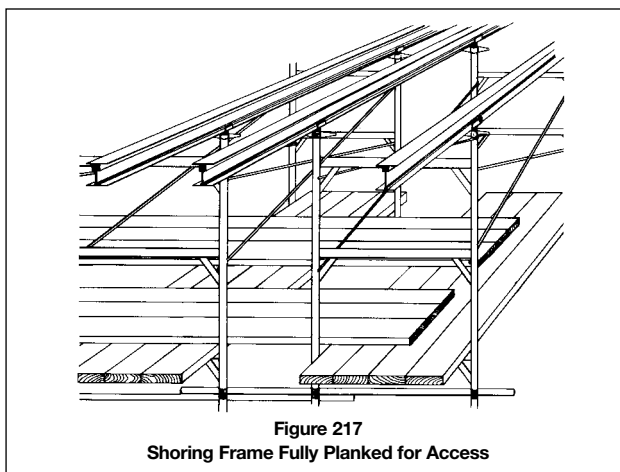

Figure 217
Shoring Frame Fully Planked for Access

The area where stripping starts should allow access for taking away material as it is dismantled.

Sound training, well-designed forms, safe access facilities, and immediate and continuous cleanup can help reduce hazards in stripping knock-down slab forms.

Built-in-Place Wall Forms

These forms are frequently of only moderate height. Taller types usually make use of large panels erected and removed by crane rather than hand.

Built-in-place wall forms are usually a stud-and-wale system using some type of ties.

Where workers cannot reach the top of the wall, scaffolding should be provided for removing wales on the upper level (Figure 218). Safe access is essential for the dismantling and manhandling of wales that are frequently long, heavy, and waterlogged.

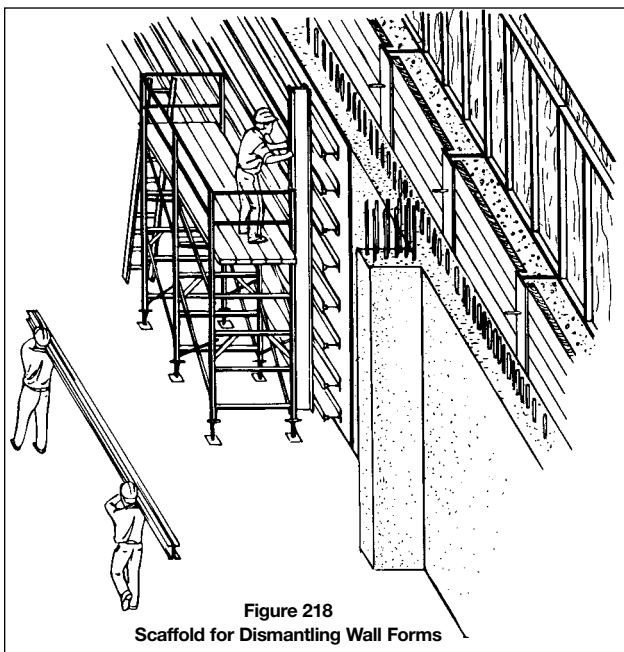

Figure 218
Scaffolding for Dismantling Wall Forms

Material should then be removed immediately to a staging area.

Inspection

Before concrete placing begins, formwork must be inspected and signed off by the designer or a competent person to ensure that it has been constructed to provide for worker safety and to meet job specifications.

In Ontario, formwork requiring design by an engineer must be inspected by an engineer or a designated competent worker. The worker does not have to be an engineer.

A report must be filed stating whether the formwork has been constructed according to the design. Any discrepancies should be cleared up with the design engineer before concrete placing proceeds.

Regardless of the specific responsibility, it is in everyone's best interest to ensure that the formwork has been inspected by a competent person for workmanship, stability, and adherence to design drawings and specifications.

Inspection should start when the forms are being constructed and continue until concrete placing is complete.

Checking line and grade is best carried out while the formwork is being constructed. Shoring structures should be within the alignment limits specified on the design

drawings. Line and grade should also be checked during the pour to determine whether formwork is shifting or deflecting.

Dimensions of special features like beams, column capitals, and inserts are best checked during construction. If inspection is delayed until formwork is completed, some details may be covered up or become more difficult to check.

Columns

Check that

- the proper size and type of materials are used
- column ties or column clamps are spaced according to design drawings
- the spacing of ties or clamps is based on a sound assessment of concrete pressure (generally columns are designed for a full liquid head of 150 pounds/foot² times height in feet)
- columns are adequately braced where they are not tied in to a slab-form structure.

Note: For more information on column formwork pressures, refer to CSA Standard S269.3, *Concrete Formwork* or the American Concrete Institute (ACI) standard *Formwork for Concrete* (SP-4).

Wall Forms

Check that

- materials and any manufactured components are as specified in design drawings (size and spacing of studs, wales, and ties are crucial to safety)
- ties are snugged up before concrete is placed
- wedges in wedged systems are tight
- nuts in threaded systems are tight
- bracing conforms to design drawings
- free-standing formwork is braced to ensure stability and resistance to loads during concrete placing
- specified pour rates are not exceeded (wall forms are often designed for specific pour rates; exceeding these rates can cause failure or collapse).

Slab Forms

From a safety perspective, this is the most critical type of formwork. The collapse of slab forms has caused many injuries and deaths, whether from flawed design, unauthorized modifications in the field, or failure to inspect.

Proper inspection demands knowledge, experience, and the ability to

- 1) distinguish between similar but different materials and shoring equipment
- 2) read and interpret design drawings
- 3) identify and clear up with the designer any apparent or real discrepancies in components such as shoring frames.

Check that

- grade beams or mud sills supporting shoring are properly sized and located
- hazardous soil conditions such as excessive moisture, freezing, and uncompacted soil are reported and discussed with the designer

- shoring frames and jacks are located and aligned within tolerances specified on the drawings
- shoring frames and jacks are out of plumb no more than 1/8 inch in 3 feet
- adjustable base plates for shoring frames and jacks are snugged up
- U-heads are wedged in place
- stringers are the specified size and number, with supports properly spaced
- aluminum stringers have no bent flanges or other damage
- joists are the specified size and properly spaced
- support structures and shoring for beam bottoms and column capitals are constructed according to design
- lateral bracing is provided where required (for instance, on freestanding formwork for bridges and overpasses)
- the bearing surface for lateral bracing is adequate — that is, stable footings or well-compacted soil
- temporary loads such as rebar are not obviously overloading the system.

Concrete Placing

Inspection of forms should continue during concrete placing. Any signs of movement, crushing, or deflection are cause for alarm. Pouring should be suspended until the situation is corrected.

Watch for the following warning signs:

- movement of single-post shoring for slab forms
- movement or deflection of lateral bracing for single-post shores
- movement of stringers on U-heads
- crushing of wooden stringers on U-heads (Figure 219)
- shoring that is not snugged up under stringers
- deflection of stringers between supports (Figure 220)
- deflection of wales or strongbacks on wall forms
- bulging of wall forms
- crushing of wales or strongbacks at washers for ties
- movement of wall forms
- uplifting of battered forms
- pour rates that exceed design specifications.

